

Compliance code

Excavation

Edition 2

December 2019



Contents

Preface	2
Part 1 – Introduction	3
Purpose	3
Scope	3
Application	3
What is excavation work?	3
Who has duties?	4
The risk management process	6
Consultation	6
Information, instruction, training and supervision	7
<i>Construction induction training</i>	8
<i>Site induction</i>	9
Part 2 – Overview of the risk management process	10
Part 2.1 – Identifying hazards	10
Part 2.2 – Assessing the risks	10
Part 2.3 – Controlling the risks	11
<i>The hierarchy of control</i>	12
<i>Maintaining risk controls</i>	13
Part 2.4 – Review and revision of risk controls	13
Part 3 – Planning excavation work	14
Health and safety coordination plans	14
Safe work method statements	15
High risk work (HRW) licensing	17
Asbestos removal and licensing	17
Notification of construction excavation work	17
Essential services and other pipes or lines	18
<i>Overhead power lines</i>	18
<i>Underground services</i>	18
Adjacent buildings or structures	19
Emergency procedures	19
Part 4 – Controlling risks in excavation work	21
Excavated material and loads near excavations	21
<i>Placing excavated material</i>	23
Securing the work area	24
Safe entry and exit	24
Plant and equipment	25
Powered mobile plant	25
<i>Blind spots</i>	26
<i>Operating near excavations</i>	27
Falls prevention	27
Falling objects	29

Using explosives	29
Atmospheric conditions and ventilation	30
Manual work	30
Emergency works.	30
Part 5 – Excavation methods.	31
Trenching.	31
Tunnelling.	31
<i>Design of tunnel.</i>	32
<i>Tunnelling hazards and risks.</i>	32
Shafts.	33
Bulk excavations.	34
Part 6 – Reducing the risk of ground collapse.	35
Ground conditions.	37
Controlling the risk of ground collapse.	39
Trench shields	40
Benching and battering.	43
Shoring.	45
<i>Closed sheeting.</i>	46
<i>Shoring terms.</i>	47
<i>Side lacing.</i>	47
<i>Steel sheet piling</i>	48
<i>Plywood panels (sandwich sheets).</i>	50
<i>Soldier set systems.</i>	50
<i>Hydraulic systems.</i>	52
Installing and removing ground support systems.	53
<i>Installing ground support systems.</i>	54
<i>Removing ground support systems.</i>	54
Regular inspection.	56
Appendix A – The compliance framework	57
Appendix B – Sample health and safety coordination plan	58
Appendix C – Safe work method statement template	59
Appendix D – Documents associated with this compliance code.	60

WorkSafe Victoria is a trading name of the Victorian WorkCover Authority.

© WorkSafe Victoria

The information contained in this publication is protected by copyright. WorkSafe Victoria hereby grants a non-exclusive licence in this publication to the recipient on the condition that it is not disseminated for profit. WorkSafe Victoria encourages the free transfer, copying and printing of the information in this publication if such activities support the purpose and intent for which the publication was developed.

This compliance code (**Code**) provides practical guidance for those who have duties or obligations in relation to excavation sites under the *Occupational Health and Safety Act 2004* (**OHS Act**) and Occupational Health and Safety Regulations 2017 (**OHS Regulations**).

The Code was developed by WorkSafe Victoria (**WorkSafe**). Representatives of employers and employees were consulted during its preparation. It was made under the OHS Act and approved by Robin Scott MP, Minister for Finance.

Duty holders under the OHS Act and OHS Regulations should use the Code together with this legislation. This Code replaces the Code of Practice (No.8) – *Safety precautions in trenching operations* (1988), which is no longer in force and effect.

While the guidance provided in the Code is not mandatory, a duty holder who complies with the Code will – to the extent it deals with their duties or obligations under the OHS Act or OHS Regulations – be taken to have complied with those duties or obligations.

If conditions at the workplace or the way work is done raise different or additional risks not covered by the Code, compliance must be achieved by other means. WorkSafe publishes guidance to assist with this at [worksafe.vic.gov.au](https://www.worksafe.vic.gov.au).

Failure to observe the Code may be used as evidence in proceedings for an offence under the OHS Act or OHS Regulations. However, a duty holder will not fail to meet their legal duty simply because they have not followed the Code.

A WorkSafe inspector may cite the Code in a direction or condition in an improvement notice or prohibition notice as a means of achieving compliance.

A health and safety representative (**HSR**) may cite the Code in a provisional improvement notice when providing directions on how to remedy an alleged contravention of the OHS Act or OHS Regulations.

Approval for the Code may be varied or revoked by the Minister. To confirm the Code is current and in force, go to [worksafe.vic.gov.au](https://www.worksafe.vic.gov.au).

Part 1 – Introduction

Purpose

1. The purpose of this Code is to provide practical guidance to duty holders about how to comply with their duties under the OHS Act and Part 5.1 of the OHS Regulations associated with **excavation work**.

Scope

2. This Code provides information for duty holders about meeting their obligations under Part 5.1 of the OHS Regulations as well as providing information on the planning, preparation, and undertaking required for excavation work, and how to identify and control risks associated with this type of work.
3. It is not possible for this Code to deal with every risk associated with excavation work that a duty holder may encounter at their workplace. The guidance in the Code needs to be considered with regard to the particular characteristics and circumstances of the workplace.

Note: Building practitioners must also comply with Victorian Building Authority (VBA) requirements for excavation work. The VBA enforces compliance with the *Building Act 1993* and *Building Regulations 2006*, including the requirement to obtain a permit to undertake certain types of excavation work before that work is carried out. For more information go to vba.vic.gov.au.

Application

4. This Code applies to employers, employees, self-employed persons, persons with management or control of a workplace, principal contractors, persons who install, erect or commission plant, and persons who design a building or structure. Additionally, it may be useful for HSRs.

Note: The word **must** indicates a legal requirement that has to be complied with. The words **need(s)** to are used to indicate a recommended course of action in accordance with duties and obligations under Victoria's health and safety legislation. The word **should** is used to indicate a recommended optional course of action.

What is excavation work?

5. For the purpose of this Code, excavation work generally means work involving the removal of earth (for example, soil or rock) from a site to form an open face, hole or cavity using hand tools, machinery or explosives and involves the relocation of earth from one position to another.

Who has duties?

6. **Employers** must provide and maintain, so far as is reasonably practicable, a working environment for their employees that is safe and without risks to health. **OHS Act s21**
To ensure that employers provide a working environment that is safe and without risk to health, they must eliminate risks to health and safety so far as is reasonably practicable, and if it is not reasonably practicable to eliminate the risks to health and safety, reduce those risks so far as is reasonably practicable. **OHS Act s20**

For information about what *reasonably practicable* means when complying with Part 3 of the OHS Act or OHS Regulations, see the WorkSafe Position – *How WorkSafe applies the law in relation to reasonably practicable* at **worksafe.vic.gov.au**.

7. Employers must, so far as is reasonably practicable, monitor conditions at the workplace under the employer's management and control. **OHS Act s22(1)(b)**
8. Employers must also, so far as is reasonably practicable, ensure that persons other than employees are not exposed to risks to their health and safety arising from the business activities undertaken by the employer. **OHS Act s23**
9. An employer's duties under section 21 and section 35 of the OHS Act extend to independent contractors engaged by the employer and any employees of the independent contractor working at the workplace. However, these extended duties are limited to matters over which the employer has control or would have control if there was not an agreement in place purporting to limit or remove that control. **OHS Act s21(3) and s35(2)**
10. Regulations that set out the way an employer complies with their duties under section 21 and section 35 of the OHS Act also apply in respect to independent contractors engaged by the employer and any employees of the independent contractor in relation to matters over which the employer has control. **OHS Regulations r8(1)**
11. Employers have a number of specific duties under Part 5.1 of the OHS Regulations to manage risks associated with excavation work **OHS Regulations r320 and r321(2)(f)**, for example to ensure that:
- any risk associated with construction work is controlled in accordance with the hierarchy of control set out in Part 5.1 of the OHS Regulations **OHS Regulations r325**
 - if there is a risk to the health and safety of any person arising from high risk construction work (**HRCW**), the work is not to be performed unless a safe work method statement (**SWMS**) is prepared before the work starts, and the work is performed in accordance with the SWMS **OHS Regulations r324 and r327**
 - employees who undertake high risk work (**HRW**), such as rigging and the operation of certain types of plant, hold an appropriate high risk work licence. **OHS Regulations r128**
12. A **self-employed** person must ensure, so far as is reasonably practicable, that persons are not exposed to risks to their health or safety arising from the business activities of the self-employed person. **OHS Act s24 and OHS Regulations r11**

Part 1 – Introduction

13. **A person who has management or control of a workplace** has a duty to ensure that the workplace and the means of entering and leaving it are safe and without risks to health, so far as reasonably practicable. This duty only applies in relation to matters over which the person has management or control. [OHS Act s26](#)
14. A **principal contractor** of a construction project costing \$350,000 or more has a duty to ensure a health and safety coordination plan is prepared before construction work (including excavation work) commences, and that this plan is monitored, maintained and kept up to date during the course of the construction work (see paragraphs 62 to 65). Principal contractors also have a duty to put in place signs that are clearly visible from outside the workplace, showing the name and telephone numbers of the principal contractor. [OHS Regulations r332 to r337](#)
15. **Employees**, while at work, must take reasonable care for their own health and safety and that of others who may be affected by their acts or omissions in the workplace. Employees must also co-operate with their employer's actions to make the workplace safe (for example, by following any information, instruction or training provided). [OHS Act s25\(1\)](#)
16. **Persons who install, erect or commission plant** who know, or ought reasonably to know, that the plant is to be used at a workplace, must ensure that nothing about the way the plant is installed, erected or commissioned makes it unsafe or a risk to health, so far as reasonably practicable. [OHS Act s31](#)
17. **Persons who design a building or structure** or part of a building or structure who know or ought reasonably to know, that the building or structure is to be used as a workplace, must ensure, so far as is reasonably practicable, that it is designed to be safe and without risks to health of persons using it as a workplace for a purpose for which it was designed. [OHS Act s28](#) In Part 5.1 of the OHS Regulations, a *structure* includes (amongst other things) a tunnel, shaft, pipe or pipeline, earthworks, earth retaining construction, or construction designed to preserve or alter any natural feature. [OHS Act s28 and OHS Regulations r323](#)

Note: The duties under Part 5.1 of the OHS Regulations do not apply to the owner of domestic premises where they personally perform construction work at those premises, or where the premises become a workplace due to construction work being performed, and the owner engages another person to manage or control the workplace. [OHS Regulations r320\(2\) and r333\(2\)](#)

The **principal contractor** is the owner of the workplace where the construction project is to be carried out, unless the owner has appointed and authorised another person to manage or control the workplace, in which case that person is the principal contractor. [OHS Regulations r5 and r333](#)

An **employer** is a person who employs one or more other persons under contracts of employment or training. [OHS Act s5\(1\)](#)

The principal contractor may be an employer or a self-employed person.

Part 1 – Introduction

The risk management process

18. This Code outlines a **risk management process** (see Diagram 1) to help employers comply with their duties under the OHS Act and OHS Regulations, including duties related to SWMS for any HRCW. It involves the following steps:
- **identifying** hazards associated with excavation work (see Part 2.1 of this Code)
 - **assessing**, where necessary, any associated risks (if unsure of appropriate risk controls) (see Part 2.2 of this Code)
 - **controlling** risks (see Parts 2.3 and 4 of this Code)
 - **monitoring, reviewing**, and where necessary, **revising** risk controls (see Part 2.4 of this Code)

Diagram 1 – The risk management process



Note: There are certain circumstances where each step of the risk management process needs to occur. See Part 4 of this Code for further information on these duties.

19. Employers must also control any risks to health and safety associated with plant used in the workplace, so far as is reasonably practicable, in accordance with a hierarchy of control under the OHS Regulations. [OHS Regulations r98](#)

Consultation

20. Employers must, so far as is reasonably practicable, consult with employees and HSRs, if any, on matters related to health or safety that directly affect, or are likely to directly affect them. This duty to consult also extends to independent contractors (including any employees of the independent contractor) engaged by the employer in relation to matters over which the employer has control. [OHS Act s35](#)

Note: The characteristics of the workplace will have an impact on the way consultation is undertaken. For example, consider:

- the size and structure of the business
- the nature of the work
- work arrangements (such as shift work)
- characteristics of employees (such as language or literacy).

Go to [worksafe.vic.gov.au](https://www.worksafe.vic.gov.au) for more information on consultation.

21. An employer has a duty to consult with employees (including HSRs) when identifying or assessing hazards or risks to health or safety at the workplace, making decisions about measures to control such risks and proposing changes that may affect the health or safety of employees at the workplace. [OHS Act s35](#)

Part 1 – Introduction

22. It is important to consult with your employees as early as possible at each step of the risk management process, including when planning to:
 - introduce new work or change existing work
 - select new equipment
 - refurbish, renovate or redesign existing workplaces
 - carry out work in new environments.
23. Employers who are required to consult on a matter must share information about the matter with employees, including relevant contractors and HSRs, give them a reasonable opportunity to express their views, and take those views into account before making a decision. If employees are represented by an HSR, the consultation must involve that HSR (with or without the involvement of the employees directly). If the employer and the employees have agreed to procedures for undertaking consultation, the consultation must be undertaken in accordance with those procedures. [OHS Act s35](#)
24. Employers also need to encourage employees and contractors to report any problems immediately so that risks can be managed before an injury occurs.
25. Employees and contractors may have practical suggestions or potential solutions that may be implemented.
26. It is important to consult with your employees as early as possible at each step of the risk management process, including when planning to:
 - introduce new work or change existing work
 - select new equipment
 - refurbish, renovate or redesign existing workplaces
 - carry out work in new environments.
27. The mix of information, instruction, training and supervision required will depend on the frequency and type of hazards in the workplace, and how much employees already know about the risks and necessary risk control measures. [OHS Act s21\(2\)\(e\)](#)
28. Information, instruction and training needs to cover the nature of hazards associated with excavation work, including the need for risk control measures and how to properly use them. For example, ensure employees understand:
 - the nature of the hazards associated with the excavation work
 - the need for and proper use of measures to control risk
 - the selection, use, fit, testing and storage of any personal protective equipment (**PPE**)
 - the content of any relevant SWMS and health and safety coordination plan.
29. Employers must provide supervision to employees where such supervision is necessary for safe work. [OHS Act s21\(2\)\(e\)](#) This is particularly important with employees who are more vulnerable in their work areas, such as new, inexperienced or young employees.
30. Supervision is important in dynamic working environments such as construction sites. Employers need to ensure that supervisors take action to enable persons to perform their work in a way that is safe and without risks to health. This should include correcting any unsafe work practices as soon as possible.
31. Where the employees undertaking the work are new and inexperienced, such as apprentices or young workers, it is often necessary to provide additional supervision.

Information, instruction, training and supervision

26. Employers must provide employees with the necessary information, instruction, training or supervision to enable them to perform their work in a way that is safe and without risks to health. This duty also extends to independent contractors (including any employees of the independent contractor) engaged by the employer in relation to

Part 1 – Introduction

32. Training programs should be practical and 'hands on'. The structure, content and delivery of the training needs to take into account any special requirements of the employees and independent contractors being trained (eg specific skills or experience, disability, language, literacy and age).
33. Employers need to review their training programs regularly and also when:
 - there is change to work processes, plant or equipment
 - there is an incident
 - new control measures are implemented
 - there is a request by an HSR
 - changes are made to relevant legislation, or
 - if any other issues impact on the way the work is performed.

Employers should also keep records of induction and training given to employees.

34. Refresher training needs to be provided as appropriate for a particular workplace. The frequency of refresher training should be determined having regard to the frequency with which employees and independent contractors are required to carry out tasks associated with excavation.
35. In addition to the general duty, two specific types of training are required in the construction industry – **construction induction training** and **site specific induction** (site induction).

Construction induction training

36. An employer must ensure that any person employed to perform construction work has completed construction induction training before they start work. This includes employees and apprentices working at the site. The construction induction training must be provided by a construction registered training organisation (**construction RTO**). OHS Regulations r339 A person's construction induction card lapses if that person has not performed any construction work for any consecutive period of two years. OHS Regulations r349

Construction induction training means a unit of competency of general occupational health and safety induction training to the construction industry endorsed or accredited under the Australian Qualifications Framework. OHS Regulations r5

37. An employer must accept any of the following things as evidence that the employee has done construction induction training including:
 - a card evidencing completion before 1 July 2008 of the Construction Industry Basic Induction Course (known as a 'red card')
 - a current '*construction induction card*' issued by WorkSafe following successful completion of induction training by a construction RTO
 - a construction statement of attainment issued by a construction RTO within the previous 60 day period, or
 - recognised evidence of construction induction training (for example, a statement or card issued under similar requirements in another Australian state or territory). OHS Regulations r343

For more information about construction induction training go to worksafe.vic.gov.au.

Part 1 – Introduction

Site induction

38. An employer must ensure that any person employed to perform construction work is provided with OHS training that relates to the particular workplace where the construction work will be performed.
OHS Regulations r330 This site induction needs to be undertaken before the person starts work at the workplace (that is, before starting work on the construction site).
39. The aim of site induction is to make sure that employees and contractors are familiar with site specific hazards, risk controls, and OHS rules and site procedures (eg the emergency procedures, arrangements for supervision of the work, and who the HSRs are).
40. The detail required in the site induction may vary between construction sites and between phases of a project. The length of time it takes may depend on things such as the size of the site, the number and variety of trades working on the site as well as how much the site is expected to change as work progresses.
41. There should be an opportunity for employees and contractors to ask questions about their responsibilities and to have any issues clarified.
42. Where an employer has information about the particular site that would form part of a site induction (eg OHS information, site specific hazards or risk controls), they need to provide that information to persons (such as contractors) performing construction work.

Part 2 – Overview of the risk management process

Part 2.1 – Identifying hazards

43. The first step in the risk management process is to identify the hazards associated with excavation work. Hazards may arise due to the excavation method being used (see Part 5 of this Code) or as a result of the excavation work itself. Examples of hazards arising from excavation work include:

- underground essential services such as gas, water, sewerage, telecommunications, electricity, chemicals and fuel or refrigerant in pipes or lines
- overhead essential services (power lines) and ground mounted essential services (transformers, gas and water pipes or mains)
- the fall or dislodgement of earth or rock
- falls into an excavation or trench
- falling objects
- inappropriate placement of excavated materials, plant or other loads in relation to the excavation or trench
- excavation entry and exit
- plant roll over into an excavation or trench
- the instability of any adjoining structure caused by the excavation
- any previous disturbance of the ground including previous excavation
- the instability of the excavation due to persons or plant working adjacent to the excavation
- the presence of or possible inrush of water or other liquid
- tree roots
- bends in excavations
- joining pipe systems
- intersections with old service excavations
- hazardous manual handling tasks
- contaminated soil, including hazardous chemicals and materials (for example asbestos) that may be present in the soil where excavation work is to be carried out
- hazardous atmosphere in an excavation (eg using Methyl Ethyl Ketone (MEK) solvent for PVC pipes in poorly ventilated trenches, using compaction equipment and generators that produce carbon dioxide)
- vibration and exposure to excessive noise
- movement of powered mobile plant and potential for pedestrian interaction
- movement of nearby vehicles (for example, when working within road reserves)
- suspended loads (eg trench shields, pipes and pits), and
- ground conditions, gradients and changes of level (including changing or unknown ground conditions).

Part 2.2 – Assessing the risks

44. A formal risk assessment is unnecessary if knowledge and understanding about the risk, and how to control it already exist.
45. If the hazards identified relate to HRCW, the employer must ensure that a SWMS has been completed. [OHS Regulations r327](#) The requirement to complete and comply with a SWMS for any HRCW applies regardless of whether a formal risk assessment is undertaken. For more information on SWMS, see paragraphs 67 to 74.

Part 2 – Overview of the risk management process

46. When assessing the risks associated with excavation work, the following needs to be considered:
- local site conditions including access, ground slope, adjacent buildings and structures, water courses (including underground) and trees
 - information about the location of essential services and other underground services, such as drainage pipes, soak wells and storage tanks, in proximity to the workplace, should be established before directing or allowing excavation work to commence
 - depth of the excavation
 - soil properties including variable soil types, stability, shear strength, cohesion, presence of ground water, effect of exposure to the elements
 - rocks which contain features such as bedding planes, fractures, faults, fissures, joints or other mechanical irregularities which could have lower strength and stability than rocks without these characteristics
 - any plant or work methods required (for example, ground support)
 - the method of transport, haul routes and disposal
 - what exposures might occur, such as to noise, ultra violet rays or hazardous chemicals
 - the number of people involved
 - the possibility of unauthorised access to the work area
 - local weather conditions, and
 - the length of time the excavation will be open.
47. For guidance on how to conduct a risk assessment go to **worksafe.vic.gov.au**.

Part 2.3 – Controlling the risks

48. Employers must control any risks to health or safety associated with excavation work, so far as is reasonably practicable, as part of providing a healthy and safe working environment. [OHS Act s21](#)
49. When considering risk control options, employers need to consider relevant information about the nature of the excavation work to be performed and how this may create a risk to health or safety. Employers also need to consider whether a risk control measure will introduce additional risks.
50. Employers must consult with their employees (including any HSRS) when making decisions about how to control risks. Consulting with employees is likely to result in better risk control measures because it gives them the opportunity to contribute ideas and is likely to improve the uptake of risk control measures when they are implemented.
51. The hierarchy of control must be followed when controlling risks. [OHS Regulations r325](#)

Part 2 – Overview of the risk management process

The hierarchy of control

52. An employer or self-employed person must, so far as is reasonably practicable, eliminate any risk to health or safety associated with construction work. **OHS Regulations r325(1)** If it is not reasonably practicable to eliminate a risk, the employer or self-employed person must reduce the risk so far as is reasonably practicable by —
- substituting, for the hazard giving rise to the risk to health or safety, a new activity, procedure, plant, process or substance that gives rise to a lesser risk to health or safety, or
 - isolating persons from the hazard, or
 - using engineering controls, or
 - combining any of those risk control measures. **OHS Regulations r325(2)**
53. It will often be necessary to use a combination of controls to eliminate or control a risk, so far as is reasonably practicable. Administrative controls and PPE are the least effective in controlling risks because they rely on human behaviour and supervision. Administrative controls and PPE may only be used where higher order risk controls are not reasonably practicable, or to supplement higher order controls. **OHS Regulations r325(3) and r(4)**

Table 1 – Hierarchy of control

Level	Example of action
1. Eliminate risk	De-energising or re-routing power lines before excavation commences in their proximity Avoid excavation by installing cables or pipes above ground or by using holed boring equipment
2. Reduce the risk with one or more of the following: <ul style="list-style-type: none">▪ substitution▪ isolation▪ engineering	Substitute an excavator with a rock breaking attachment rather than using a manual method Isolate pedestrians from powered mobile plant using concrete barriers to reduce the risk of collision Use engineering controls such as benching, battering or shoring the side of the excavation to reduce the risk of ground collapse
3. Reduce the risk using administrative controls	Install warning signs zone to stop people entering an area where demolition debris may fall
4. Reduce the risk by using personal protective equipment (PPE)	Use hard hats, hearing protectors and high visibility vests

Part 2 – Overview of the risk management process

Note: In addition to the above hierarchy of control for construction work, the OHS Regulations set out specific hierarchies of control for other hazards that may be present on an excavation site including falls, hazardous substances, hazardous manual handling, confined spaces, plant, noise, asbestos and lead. For information about applying the specific hierarchies for these hazards go to worksafe.vic.gov.au.

54. Parts 4 to 6 of this Code provide information about risk controls for excavation work.

Maintaining risk controls

55. A person who is required by the OHS Regulations to use any particular measure to control risk must ensure that the measure is properly installed (if applicable), used and maintained. [OHS Regulations r18](#)
56. The purpose of maintaining risk controls is to ensure that they are working as originally intended and adequately control risk associated with excavation work. Maintenance of risk controls needs to include:
- monitoring excavation activities and work practices
 - regular inspections of physical controls such as trench shields and shoring or stability of benching and batters
 - visual checks to ensure risk controls that rely on human behaviour are being properly applied by employees
 - testing of equipment and PPE
 - preventative maintenance of engineering controls and PPE, and
 - any necessary remedial work to ensure physical controls continue to work effectively.

57. Employers and self-employed persons need to have a maintenance procedure and monitoring processes in place to ensure that any defects in risk controls are detected as early as possible.

Part 2.4 – Review and revision of risk controls

58. An employer or self-employed person must **review** any risk controls implemented, and **revise** them if necessary in the following circumstances:
- before any change is made to the way the excavation work is performed or to the system of work associated with the excavation work, including any change in the location of the excavation work
 - if new or additional information about hazards relating to the excavation work becomes available to the employer
 - if, for any other reason, the risk controls do not adequately control the risks, or
 - after receiving a request for review from an HSR. [OHS Regulations r326\(1\)](#)
59. An HSR can make a request if they believe on reasonable grounds that:
- any of the circumstances listed above exist
 - the employer has failed to properly review risk controls, or
 - in conducting a review of, or revising the risk controls, the employer has failed to take into account any of the circumstances listed above (for example, the HSR believes that the employer has failed to consider a change to a system of work that may increase risk, during their review of risk controls). [OHS Regulations r326\(2\)](#)

Part 3 – Planning excavation work

60. Excavation work needs to be carefully planned before work starts so it can be carried out in a way that is safe and without risks to health. Planning involves identifying hazards and risks, assessing risks where necessary, and determining appropriate risk controls in consultation with all relevant persons involved in the work. This should include the principal contractor, excavation contractor, structural or geotechnical engineers, mobile plant operators, employees undertaking the work and HSRs.
61. Ground collapse prevention methods need to be designed in accordance with appropriate engineering principles and published Australian Standards. Engineering principles would include, for example, mathematical or scientific calculations outlined in an engineering reference manual or Australian Standard. When conditions warrant, an employer should have a suitably qualified person (for example, a geotechnical engineer) conduct an investigation and deliver an engineering investigation report before the excavation work starts or when expected circumstances or conditions change.

Employers must, so far as is reasonably practicable, employ or engage persons who are suitably qualified in relation to occupational health and safety to provide advice to the employer concerning the health and safety of employees of the employer.

OHS Act section 22(2)(b)

The WorkSafe position on ***suitably qualified*** provides that it means having the knowledge, skills and experience to provide advice on the issues impacting the health and safety of employees of the employer. The type of person required will depend on the circumstances. Sometimes a person with formal qualifications will be needed, at other times industry experience may be sufficient. For more information see the WorkSafe position at **worksafe.vic.gov.au**.

Health and safety coordination plans

62. Principal contractors for construction projects valued over \$350,000 (value or cost of the whole construction contract, not just the excavation phase) must ensure that a health and safety coordination plan is prepared before construction work commences. **OHS Regulations r335(a)**
63. The plan must include:
 - a list of names, positions and responsibilities of all persons who will have specific responsibilities for onsite health and safety (eg site managers, OHS officers, first aid officers, and specialist contractor supervisors)

Part 3 – Planning excavation work

- the arrangements for the coordination of the health and safety of persons engaged to perform construction work (eg duties of responsible person, and how these persons will communicate with employees)
 - the arrangements for managing OHS incidents when they occur (eg emergency response, notification of emergency services and WorkSafe), and
 - any site safety rules and arrangements for ensuring that all persons at the workplace are informed of the rules.
OHS Regulations r336
64. The health and safety coordination plan must be monitored, maintained and kept up to date during the course of the construction work. **OHS Regulations r335(b)** The principal contractor must ensure that a copy of the plan and any revisions are retained for the duration of the project and are available for inspection by:
- any person engaged to perform construction work at the workplace
 - any person about to commence work at the workplace
 - an employee member of a health and safety committee, an HSR or a nominated employee representative.
OHS Regulations r337(1)
65. Each person engaged to perform construction work must be made aware of the health and safety plan before they commence work and be provided with access to the plan and any revisions.
OHS Regulations r337(2)
66. See paragraph 104 for guidance on the incorporation of emergency plans into health and safety coordination plans. See **Appendix B** for a health and safety coordination plan template.

Safe work method statements

67. An employer or self-employed person must not perform HRCW if there is a risk to the health or safety of any person arising from the work, unless:
- a SWMS has been prepared before the work commences, and
 - the work is performed in accordance with that statement. **OHS Regulations r327(1)**
68. If there is non-compliance with a SWMS when work is being performed, an employer or self-employed person must:
- stop the work immediately or as soon as it is safe to do so, and
 - not resume the work until the SWMS is complied with or reviewed and, if necessary, revised.
OHS Regulations r327(2)
69. An employer or self-employed person performing HRCW for which a SWMS is required must review and, if necessary, revise the SWMS:
- whenever the HRCW changes, or
 - if there is an indication that risk control measures are not controlling the risks adequately, including after any incident that occurs during HRCW.
OHS Regulations r328
70. A SWMS is a document that must:
- identify work that is HRCW
 - state the hazards and risks to health or safety of that work
 - sufficiently describe measures to control those risks
 - describe how the risk controls are to be implemented, and
 - be set out and expressed in a way that is readily accessible and comprehensible to the persons who use it.
OHS Regulations r324

Part 3 – Planning excavation work

71. A SWMS should be developed after, or in conjunction with, a risk assessment and needs to describe all risk-control measures that are being used in relation to the HRCW.
72. Many tasks undertaken as part of an excavation project involve HRCW, for example where:
- there is a risk of a person falling more than two metres
 - the removal or likely disturbance of asbestos is involved
 - structural alterations that require temporary support to prevent collapse are used
 - there is a confined space
 - the excavated depth of a trench or shaft is more than 1.5 metres
 - a tunnel is involved
 - explosives are used
 - work is done on or near:
 - pressurized gas distribution mains or piping
 - chemicals, fuel or refrigerant lines
 - energised electrical installations or services
 - the work is done in an area that may have a contaminated or flammable atmosphere
 - it involves tilt-up or precast concrete
 - work is done on or adjacent to roadways or railways used by road or rail traffic
 - demolition is involved
 - there is any movement of powered mobile plant, or
 - there is a risk of drowning.
[OHS Regulations r322](#)
73. If a geotechnical engineer provides advice the employer needs to ensure this is reflected in the SWMS.
74. A SWMS for construction work on excavation sites may have to address multiple HRCW activities. One SWMS can be prepared to cover all HRCW on an excavation site provided it takes into account the changing nature of the construction environment. Alternatively a separate SWMS can be prepared for each type of HRCW. This may be more appropriate for complex excavation projects where separate SWMS may need to be prepared for HRCW due to the diverse nature of the HRCW involved (eg risks of falls from height, use of explosives, removal or likely disturbance of asbestos, and movement of powered plant).
75. Employers must, so far as is reasonably practicable, consult with employees and HSRs, if any, on matters related to health or safety that directly affect them. [OHS Act s35](#) The duty to consult applies when, for example, identifying or assessing hazards or risks to health or safety or making decisions about risk control measures, including when preparing or revising a SWMS.
76. See **Appendix C** for an example of a SWMS template. For more information on how to prepare a SWMS go to [worksafe.vic.gov.au](https://www.worksafe.vic.gov.au).

Part 3 – Planning excavation work

High risk work (HRW) licensing

77. A person must not do any HRW unless they hold an appropriate HRW licence. OHS Act s40(4), OHS Regulations r128 and r130 The range of HRW licences are listed in Schedule 3 of the OHS Regulations and include licences for the use of cranes, elevated work platforms, and for dogging and rigging. This is in addition to the duty to provide employees with any necessary information, instruction, training and supervision to enable them to perform their work in a way that is safe and without risks to health (go to Part 1 of this Code).
78. An employer must ensure that any employee who will be performing HRW holds an appropriate HRW licence in relation to that work. OHS Regulations r129 For information about licensing, including how to apply for a HRW licence and exceptions that apply, go to worksafe.vic.gov.au.

Asbestos removal and licensing

79. Persons who manage or control workplaces and employers have specific duties in relation to asbestos, including licensing requirements. See Part 4.4 of the OHS Regulations.
80. For guidance about asbestos removal and licensing refer to the *Removal of asbestos in workplaces compliance code* at worksafe.vic.gov.au.

Notification of construction excavation work

81. Unless certain exemptions apply, WorkSafe must be notified in writing at least three days before work starts on an excavation that will be of sufficient dimensions or depth to allow the entry of a person, or if there will be a risk to the health or safety of any person from the excavation. The written notification must be in accordance with regulation 355. OHS Regulations r354 and r355
82. WorkSafe needs to be notified of work on the following types of excavations:
- a shaft (two metres or deeper)
 - a trench (1.5 metres or deeper), and
 - a tunnel that a person can enter.
83. The employer can make one notification for a construction excavation associated with a single project which may cover several locations and be carried out over a period of time.
84. Notification is not required if the excavation is of a shaft or trench made as part of building work for which a building permit has been issued and is in force under the *Building Act 1993*. OHS Regulations r354(2)
85. Notification is also not required if the excavation of a shaft, trench or tunnel is:
- a mine
 - a bore (as defined in the *Water Act 1989*)
 - a quarry (as defined in the *Mineral Resources (Sustainable Development) Act 1990*)
 - made for the purpose of undertaking emergency work
 - made for the rescue of any person or the carrying out of an emergency response by an emergency service

Part 3 – Planning excavation work

- made for use as a place of burial or interment of the dead (for example, a grave). OHS Regulations r354(3)

86. For a copy of the WorkSafe notification of construction excavation work form go to worksafe.vic.gov.au.

Essential services and other pipes or lines

87. Services relevant to excavation work include:
- underground services such as gas, water, sewerage, telecommunications, electricity, chemicals, fuel and refrigerant in pipes or lines
 - overhead services such as power lines and ground mounted services such as transformers, gas and water pipes or mains.
88. An important element of pre-excavation planning is the identification, protection, relocation, flushing, de-energising, removal or decommissioning of all essential services and other pipes or lines.

Note: It is important to verify that gas and electricity services that may be impacted by the excavation work are positively de-energised and disconnected and, where appropriate, purged.

89. In each case, the asset owner involved needs to be notified in advance and its approval for services, if necessary, obtained. Any service retained for excavation work (for example, overhead electric lines) needs to be adequately protected as required by the relevant authority.

Overhead power lines

90. Risk controls need to be implemented before using plant (for example, excavators or other earthmoving machinery) near overhead power lines. The relevant authority should be consulted regarding approach distances and appropriate risk controls implemented to prevent any part of the plant or any load carried on it from coming too close or contacting overhead power lines.
91. When operating powered mobile plant near power lines, the SWMS needs to detail how this task will be done safely and the types of risk controls that have been put in place such as 'no go zone' rules.

Underground services

92. An employer needs to ensure that underground services are identified before doing excavation work or ground penetration work. 'Dial Before You Dig' is a free service that provides information on all known underground services. Information includes registered pipelines, water and gas pipes, electrical and telecommunication cables, and other underground obstructions that the asset owner has registered with the service. An enquiry also alerts owners to work being done near their assets.
93. 'Dial Before You Dig' may not contain complete information about all underground services. Where there is limited information available on underground services, an employer needs to seek advice from the relevant asset owners or another method needs to be used (for example, cable location device to identify the asset location). The employer needs to ensure that hand digging or non-destructive excavation is used to locate the asset before starting mechanical excavation (for example, sampling the area by exposing a short section of underground service usually using water pressure and a vacuum system or *pothole* the area) – see Figure 2.

Part 3 – Planning excavation work

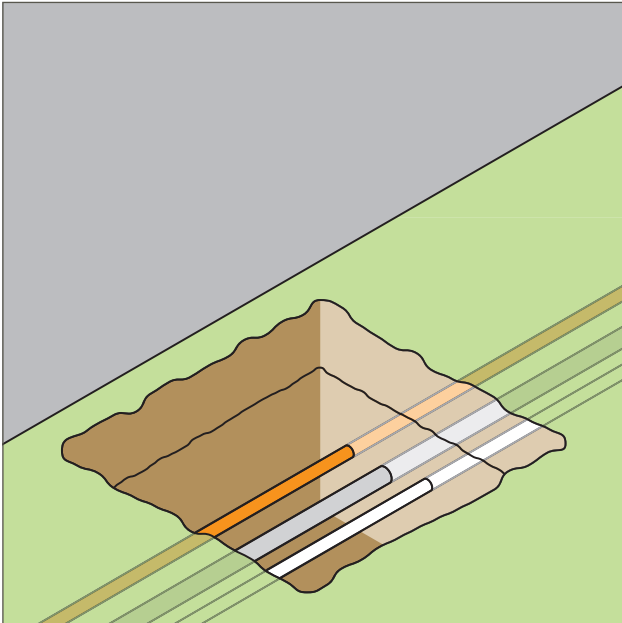

Figure 2 – Underground services exposed by potholing

94. Where underground services may be impacted, the employer needs to ensure that the location of underground services are physically marked (for example, with signposts or spray paint) in a way that is conspicuous and not easily removed.
95. For further guidance on overhead power lines and underground essential services go to worksafe.vic.gov.au.

Adjacent buildings or structures

96. When planning excavation work (particularly bulk excavations), consideration needs to be given to adjacent buildings or structures. The excavation needs to be undertaken in a way that does not adversely affect the security or stability of any part of a building or structure at or adjacent to the location of the proposed excavation, as this could lead to structural failure or collapse.

97. Employers need to ensure that excavation work does not commence until steps are taken to prevent the collapse or partial collapse of any potentially affected building or structure.
98. An employer needs to ensure that any excavation that is below the level of the footing of any structure (including retaining walls) that could affect the stability of the structure is assessed by a suitably qualified person (for example, a geotechnical engineer). The excavation should be secured by a suitable ground support system designed by a suitably qualified person (for example, a structural or geotechnical engineer). Suitable supports to brace the structure may also be required.
99. It is also important that other buildings in and around the excavation site are not adversely affected by vibration or concussion during the excavation work. Special precautions should be taken in the vicinity of hospitals and other buildings containing equipment sensitive to shock and vibration.
100. Excavation work should be carried out in a way that does not cause flooding or water penetration to any adjacent building.

Emergency procedures

101. An employer must establish emergency procedures before construction work is undertaken if there is a risk of a person becoming engulfed by soil or other material when the work is performed (subject to limited exceptions). **OHS Regulations r331(1)** The employer must ensure that the emergency procedures, so far as is reasonably practicable, enable —
 - the rescue of a person in the event that the person becomes engulfed by soil or other material, and

Part 3 – Planning excavation work

- the provision of first aid to a person who has become engulfed. **OHS Regulations r331(3)(a)**
102. The employer must ensure that the emergency procedures can be, and are, carried out immediately after a person becomes, or is likely to become, engulfed. **OHS Regulations r331(3)(b) and r331(5)**
103. Any risk associated with carrying out the emergency procedures must be eliminated, so far as is reasonably practicable, or if it is not reasonably practicable to eliminate the risk, reduced so far as is reasonably practicable. **OHS Regulations r331(4)**
104. An emergency procedure needs to reflect the site location, ground conditions and the type of work to be undertaken. They should be contained in or appended to a SWMS, and need to be regularly reviewed and modified as conditions change. To ensure a coordinated emergency response, emergency procedures should be incorporated into the health and safety coordination plan prepared by the principal contractor. Complex and large-scale projects may require a separate emergency procedure.
105. Emergency procedures need to include details of:
- nearest medical facilities
 - first aid provisions
 - reliable method of communication, and
 - the need to continue on-site emergency rescue of the person if the relevant emergency services do not respond, are delayed or are unable to deal with the emergency.
106. Employers must provide information, instruction and training to employees as is necessary for safe work **Section 21(2)(e) OHS Act** For example, employees need to have access to and training in emergency procedures. Employers should include such training as part of the site specific induction training. Regular practice runs of all relevant procedures should be held.
107. An employer should not assume that local emergency services have the capacity or equipment to provide on-site emergency medical or rescue services. Poor vehicle access (for example, rough or muddy terrain) can delay or stop standard emergency vehicles. Consultation with local emergency services, and maintaining a mechanism or capacity to assist in an emergency, will lead to a more effective coordinated response in case of an emergency.
108. For information about first aid refer to the *First aid in the workplace compliance code* available at **worksafe.vic.gov.au**.
109. Employers also need to be aware of their duties regarding emergency response procedures if the excavation work involves a risk of fall **OHS Regulations r49** or is undertaken in a confined space **OHS Regulations r69 to r72**. For more information on these separate requirements, refer to the *Prevention of falls in general construction compliance code* and the *Confined spaces compliance code* at **worksafe.vic.gov.au**.

Part 4 – Controlling risks in excavation work

Employers must, so far as is reasonably practicable, consult with employees and HSRs, if any, on matters related to health or safety that directly affect, or are likely to directly affect them. The duty to consult applies when, for example, making decisions about risk control measures and proposing changes that may affect the health or safety of employees at the workplace. **OHS Act s35**
See pages 6 and 7.

Excavated material and loads near excavations

110. Any material such as mechanical plant, vehicles, or storage of materials (including excavated materials such as the spoil pile) will add further weight to the area where it is placed. It is important that materials are not placed or stacked near the edge of the excavation or inside the 'zone of influence' (see paragraph 113) unless the ground conditions allow for it or a ground support system has been installed which has been designed to carry such loads. Placing materials in areas that cannot hold the weight puts people working in the excavation at increased risk as the extra load could cause the excavation to collapse.

111. The distance between the edge of the excavation and any excavated material should not generally be less than 500mm. How close a load can safely be located next to the edge of an excavation will depend on the ground conditions and the type of ground support in place. The design of a ground support system should specify the distance from the edge that materials can be placed or stacked.

112. Figure 3 shows an example of:

- an excavation with shoring that has been designed to carry vehicle and material loads – this may be required where there is limited space around the excavation for vehicle movement or material storage, and
- an excavation with no shoring, designed to carry soil loads only.

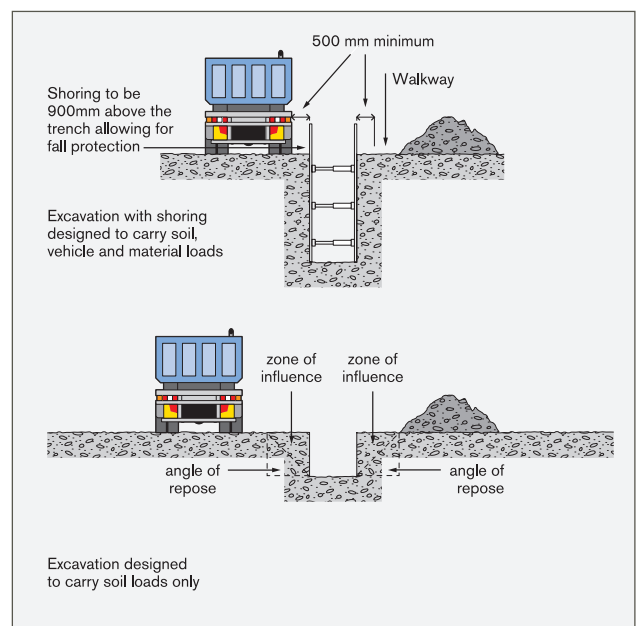

Figure 3 – Excavated material and loads near excavations

113. The '**zone of influence**' is a theoretical zone in which the risk of ground collapse may increase if plant or material is placed within that zone and is dependent on ground conditions. Figure 3 shows the relationship between the zone of influence and the angle of repose.

Part 4 – Controlling risks in excavation work

114. The **'angle of repose'** is the slope at which dumped or excavated soil is naturally stable and does not fall away. This determines the angle of repose (see Figure 4). The angle of repose should not be greater than 45 degrees for the purpose of determining whether a ground support system is required. If it is proposed to have an angle higher than the angle of repose of the spoil pile, a geotechnical analysis needs to be undertaken before excavation work commences.

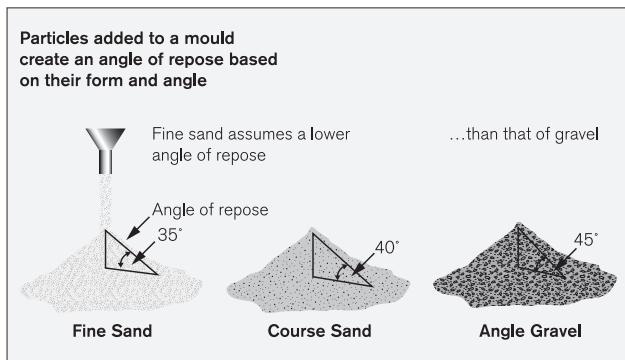

Figure 4 – Examples of angles of repose for certain materials

115. An employer needs to ensure that pipes to be laid, and equipment for laying pipes (for example, excavators), are placed away from the top of the excavation to ensure they do not collapse or roll into the excavated area (see Figures 5a and 5b).

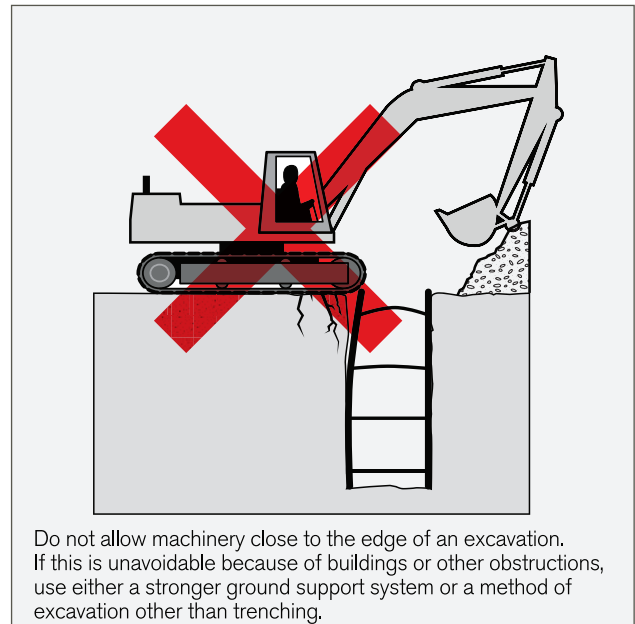

Figure 5a – An example of machinery being too close to the edge of an excavation

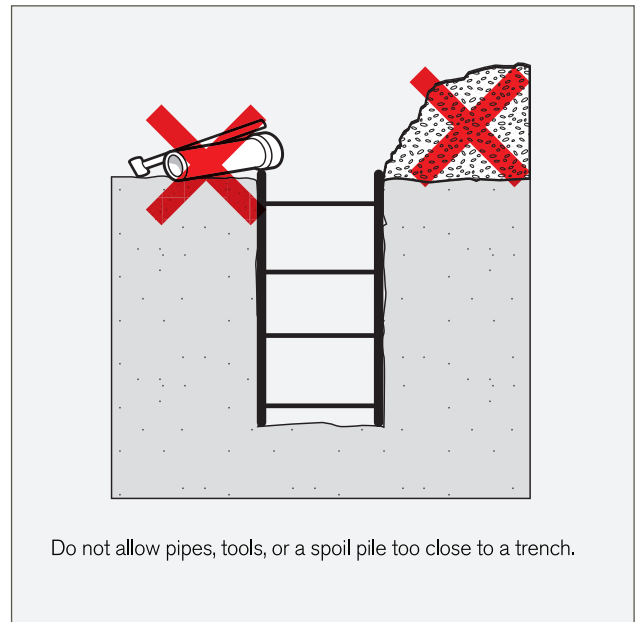

Figure 5b – An example of a spoil pile and equipment being too close to the edge of an excavation

Part 4 – Controlling risks in excavation work

Placing excavated material

116. If excavating in sloping ground, the employer needs to ensure that excavated material (for example, the spoil pile) is placed on the down-slope side of the excavation. In addition, the following need to be considered:
- ground conditions
 - changes to climate or weather conditions
 - access to the excavation
 - existing underground services
 - the need for earthmoving machinery or vehicles to work or move along beside the excavation
 - service installation and backfilling requirements, and
 - any manual work being undertaken in the excavation.
117. Placing material on the up-slope side of the excavation increases the effective height (or depth) of the excavation (see Figure 6). Placing material on the down-slope side of the excavation will avoid this and also assist in controlling the risk of material falling or being washed into the excavation.

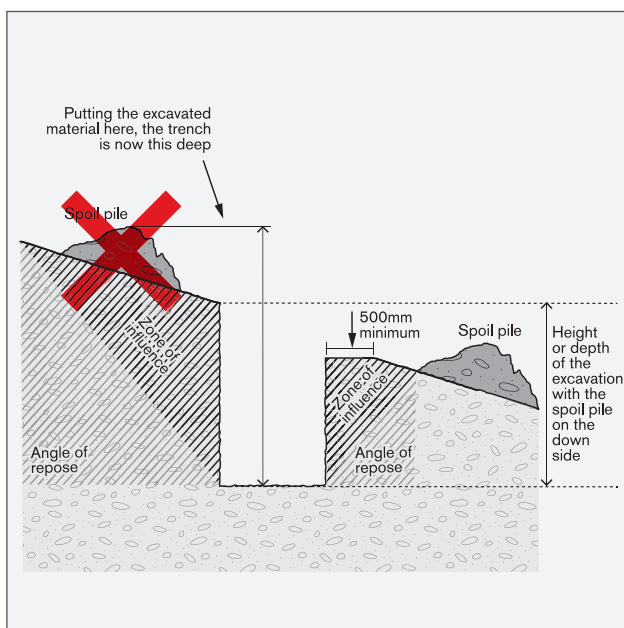

Figure 6 – Excavated material impact on effective excavation depth

118. Material should not be placed on the high side of the excavation as this increases the risk of ground collapse or flooding. Excavated material should be placed so that it channels rainwater and other run-off water away from the excavation (for example, a small ditch or channel could be constructed to divert rainwater away to prevent flooding of excavations).
119. When a trench is being excavated beside an existing service line, the excavated material needs to be placed on the side opposite the existing service line to prevent excessive loading on previously disturbed ground.
120. To ensure safe access along all sides of an excavation, the toe of the excavated material needs to be at least 500mm from the edge of the excavation. If excavated material is placed close to an excavation due to obstructions such as fences, buildings or trees, the weight of the excavated material may overload the sides of an excavation. In this case, the excavated material may be moved elsewhere or the ground support system may need to be strengthened at these locations, and barriers such as toe boards need to be provided to prevent the material falling into the excavation.
121. Toe boards reduce the risk of excavated material sliding into the excavation. Retaining toe boards or trench shields need to protrude at least 300mm above the toe of the spoil pile (Note: that this height does not provide adequate fall protection, see paragraphs 133 to 134).

Part 4 – Controlling risks in excavation work

Securing the work area

122. In securing the trench or excavation, employers need to consider the risks arising from unauthorised access to the work area. To ensure the protection of employees and members of the public on or near the excavation site, it is important to restrict access to the excavation area.
123. Members of the public need to be prevented from entering the excavation site when it is unattended. Trenches should be covered to prevent unauthorized entry. Road plates, for example, can be used to cover an excavation on a roadway.

Safe entry and exit

124. If employees or other people are required to enter an excavation, the employer or person with management or control of the workplace needs to ensure a safe method to enter and exit is provided. This may include a landing platform and a sufficiently long, secure internal ladder.
125. Additional access equipment may be required to provide safe access to other locations in an excavation (for example, in order to connect or disconnect a sling from a trench shield). Adjustable walkways (see Figure 7), temporary platforms and other access equipment fitted with guardrails can provide safe access into and within, over or across the excavated site.

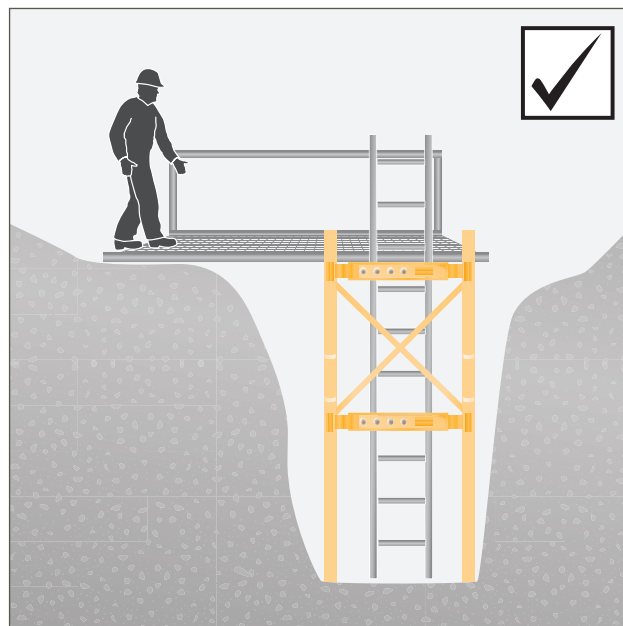

Figure 7 – Example of a safe entry point for trenching

Part 4 – Controlling risks in excavation work

Plant and equipment

126. Part 3.5 of the OHS Regulations applies to plant, and sets out specific requirements for duty holders. Among other things, employers need to ensure that where plant is used in excavation work:
- the plant is appropriate for the excavation work and is maintained in good condition
 - the plant is used and operated by a competent and, where required, licensed person
 - appropriate guards and operator protective devices are fitted
 - the safe working load (where applicable) is displayed and any load measurement devices are operating correctly, and
 - the plant is maintained in accordance with the manufacturer's or supplier's instructions.
127. Further guidance on plant, including powered mobile plant, can be found in the *Plant compliance code* at **worksafe.vic.gov.au**.

Powered mobile plant

128. Powered mobile plant such as earthmoving machinery is frequently used for excavation work. To select plant that is suitable for the task, an employer needs to consider:
- site access and restrictions
 - site hazards such as overhead power lines and underground services
 - ground conditions
 - type and depth of excavation
 - volume of material to be excavated and the potential requirement for it to be placed offsite, and
 - where the excavated material is to be located or stored.

Part 4 – Controlling risks in excavation work

Blind spots

129. Operators of powered mobile plant may have restricted visibility of nearby employees or pedestrians, particularly those close to the plant. Figure 8 shows some of the blind spots for operators of typical excavation equipment.

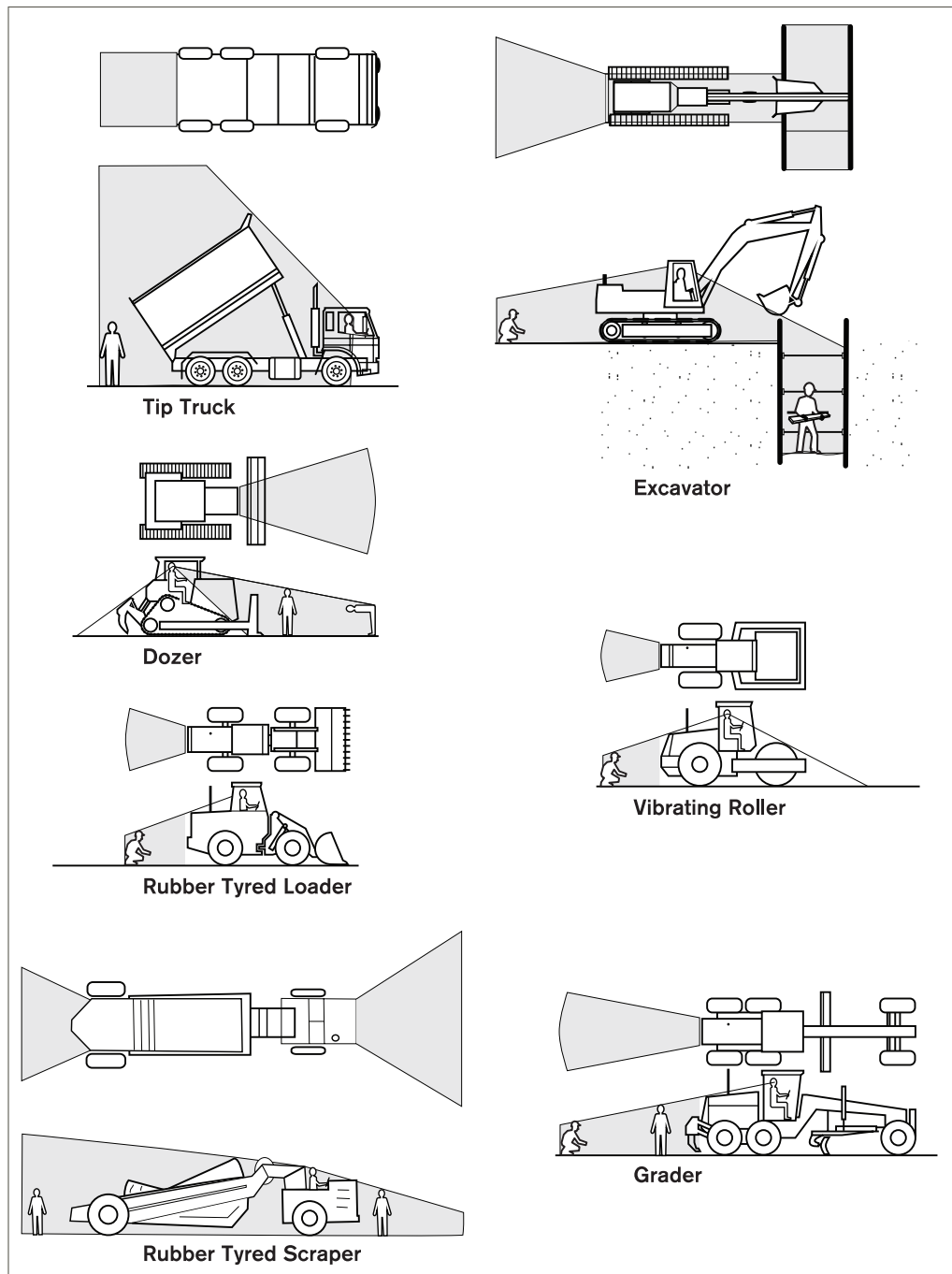

Figure 8 – Blind spots where operators may not see ground workers

Part 4 – Controlling risks in excavation work

Operating near excavations

130. An employer needs to ensure that powered mobile plant, including earthmoving machinery such as bulldozers, does not operate or travel near the edge of an excavation unless the ground support system installed has been designed by a suitably qualified person (for example, a geotechnical engineer) to carry such loads (see Figures 3 and 5a).
131. Employers need to control risks associated with job layout, haul roads, vehicle pathways and traffic management. Temporary haul roads need to be well constructed and maintained to enable plant operators to complete the work safely.
132. An employer needs to ensure that plant always approach embankments or trenches from across the line of a trench rather than parallel to it.

Falls prevention

133. An employer has a general duty to control risks associated with falls from any height, including falls into an excavation.
134. Risk controls for falls into an excavation include:
 - the support system itself (for example, using trench box extensions or trench sheets with a height greater than the trench depth)
 - installing guard rails or covers on trench shields (see Figure 9); where possible, guard railing needs to be fitted before installing the trench shields or form part of the shield
 - inserting guard rails and toe boards into the ground immediately next to the supported excavation side
 - installing landing platforms or access structures such as scaffold towers inside deep excavations

- securing ladders to trench shields
- installing effective barriers or barricades
- providing clearly defined pedestrian detours
- provision of alternative entry and exit points to the excavation for emergency use
- backfilling the excavation as work progresses
- fencing around excavations or trench shields which extend at least 900mm above ground, thus providing appropriate edge protection

Note: trench shields which have the capacity to accommodate guard rail sections are appropriate risk controls (see Figure 10).

- bridge units that span wider trenches and incorporate ladder points to enable entry and exit from trench shields
- where an excavation is being worked on in an unpopulated area (for example, a greenfield estate), barricades set back an appropriate distance (for example, two to three metres) and signage may be an appropriate means of preventing persons from approaching live edges.

Part 4 – Controlling risks in excavation work

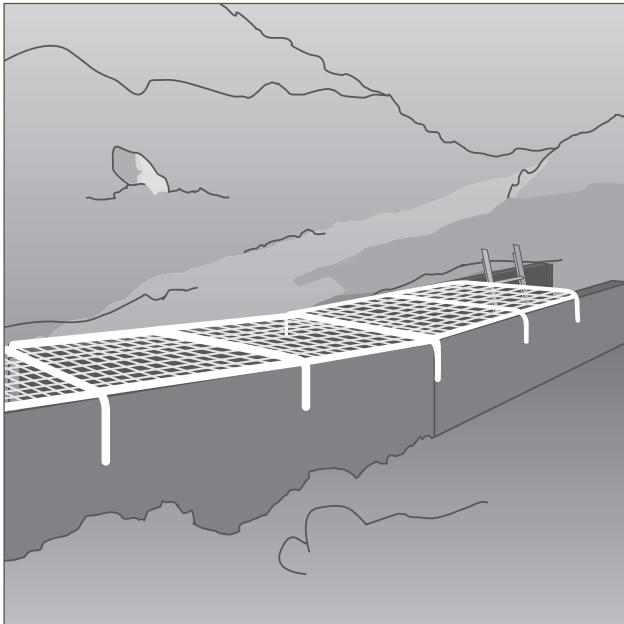

Figure 9 – Steel mesh covers over trench shields

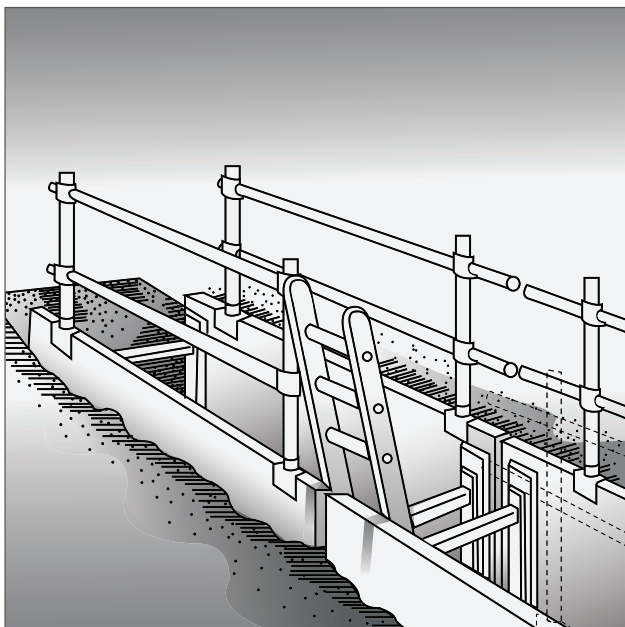

Figure 10 – Trench shields with guard rails attached and safe access provided by a tied off ladder

135. Part 3.3 of the OHS Regulations places specific obligations on employers to manage risks associated with involuntary falls greater than two metres. This includes duties to:

- identify all tasks that involve a fall risk of more than two metres
OHS Regulations r43
- manage risks associated with a fall in accordance with the hierarchy of control set out in regulation 44.
OHS Regulations r44, and
- ensure that any plant used to control a risk associated with a fall is fit for its purpose, safe to use in the particular work environment and is installed, erected and dismantled safely. OHS Regulations r47

Part 4 – Controlling risks in excavation work

136. A SWMS must be prepared for construction work that involves a risk of a person falling more than two metres. **OHS Regulations r322(a) and r327** This is in addition to the requirement to prepare a SWMS for any trench or shaft deeper than 1.5m (see paragraphs 67 to 74).
137. For guidance on controlling risks associated with falls, see the *Prevention of falls in general construction compliance code* and the *Prevention of falls in housing construction compliance code*.

Falling objects

138. An employer must provide appropriate personal protective equipment to persons at risk from construction work. **OHS Regulations r325(4)** Employers need to ensure that employees doing excavation work wear safety helmets.
139. Helmets need to be worn by anyone entering an excavation site, whether they are involved in the work directly, inspecting the excavation or simply touring the area.
140. Eye protection should be worn to reduce the risk of eye injury which may result from small materials or soil rolling into the excavated area.
141. Where loads are to be suspended via lifting hooks (eg trench shields, road plates, pit or pipe sections) the hooks need to be attached to purpose designed lifting points in a manner that requires a deliberate action to release the connection (eg a self-locking hook or hook with latch). Connections that rely on gravity alone (ie open hooks) should be avoided as they may dislodge due to the movement of the lifting equipment or load.

Using explosives

142. Construction work that involves the use of explosives is HRCW and a SWMS must be prepared before this work commences. **OHS Regulations r322(i) and r327**
143. The use of explosives as an excavation method should only be considered when it is not reasonably practicable to undertake the excavation by any other method.
144. A person must be licensed by WorkSafe to use blasting explosives. If explosives are used in excavation work, a licensed person must develop a blast management plan and be responsible for all aspects of the use of explosives in the excavation. **Dangerous Goods (Explosives) Regulations 2011 r125 and r130**
145. A blast management plan must be in accordance with the applicable requirements of AS 2187.2 *Explosives – storage and use – use of explosives*, and must include a plan for dealing with any misfire. It must also be commensurate with the size, location, nature and complexity of the blasting operation to be undertaken. **Dangerous Goods (Explosives) Regulations 2011 r130**
146. A suitably qualified person (for example, a person licensed and experienced in the controlled application of explosives for excavation purposes) should be consulted before deciding whether explosives may be used for the excavation.
147. All possession, storage, handling and use of explosives must be carried out in compliance with the *Dangerous Goods Act 1985* and the *Dangerous Goods (Explosives) Regulations 2011*. For more information on these duties, go to **worksafe.vic.gov.au**.

Part 4 – Controlling risks in excavation work

Atmospheric conditions and ventilation

148. The risk of contamination through a build-up of gases and fumes needs to be controlled in excavation work. Gases and fumes heavier than air can accumulate in trenches, tunnels and excavations (eg gases such as sulphur dioxide, engine fumes such as carbon monoxide and carbon dioxide, leakage from gas bottles, fuel tanks, sewers, drains, gas pipes, and LPG tanks).
149. Guidance on working in confined spaces is available in the *Confined spaces compliance code* at worksafe.vic.gov.au.

Manual work

150. Manual excavation methods are generally used for small, shallow excavations in soft soils.
151. When working in close proximity, the employer needs to provide and maintain a system of work to keep employees sufficiently far apart to prevent injury from the use of picks or other hand tools. This applies particularly to work in trenches and small excavations.
152. Using hand tools and working in cramped conditions (for example, trenches) increases the risk of musculoskeletal injury from twisting and bending or from being struck by other workers. Preparatory drilling activity and the use of hand drills may increase the risk of musculoskeletal disorders from exposure to vibration and twisting.
153. For guidance on controlling risk of musculoskeletal disorders, see the *Hazardous manual handling compliance code* available at worksafe.vic.gov.au.

Emergency works

154. Emergency works on an underground essential services asset (such as repairing a damaged gas or water pipe) may require excavation work. The urgent nature of the works does not exempt a duty holder from obligations under the OHS Act or OHS Regulations.
155. Hazards and risks associated with excavation work when carrying out emergency works on essential services may include:
 - leaking gas when excavating to repair a damaged gas pipe
 - water escaping from a broken water main, affecting the stability of the excavation
 - disturbed ground conditions.
156. Careful planning of the excavation works and risk management needs to be undertaken despite the time dependent nature of the work.
157. If emergency works involve HRCW, and there is a risk to the health and safety of any person arising from that work, an employer must ensure that a SWMS is prepared before the work starts, and the work is performed in accordance with the SWMS. [OHS Regulations r327](#) See paragraphs 67 to 74 for guidance on HRCW and SWMS.
158. If there is a risk of ground collapse, appropriate ground collapse risk controls need to be used to protect employees who need to enter the excavation to carry out emergency repair works. See Part 6 of this Code for further information on controlling the risk of ground collapse.

Part 5 – Excavation methods

Employers must, so far as is reasonably practicable, consult with employees and HSRs, if any, on matters related to health or safety that directly affect, or are likely to directly affect them. The duty to consult applies when, for example, making decisions about risk control measures and proposing changes that may affect the health or safety of employees at the workplace. [OHS Act s35](#)
See pages 6 and 7.

159. The nature of the excavation work being undertaken will affect the selection of excavation method and safe system of work.

Trenching

160. A trench is an excavation where the length is greater than its width and greater than or equal to its depth, and is used or to be used for the laying, removal or repair of pipe or cable. [OHS Regulations r5](#)
161. Risks arising from the collapse of a trench can be reduced by protecting employees with the use of trench shields or by ensuring that all sides of the trench are adequately stabilised by one or more of the following ground collapse prevention methods:
- positive ground support such as shoring or other comparable means
 - benching
 - battering.

162. A combination of the risk controls set out above need to be used where required to control risks arising from collapse so far as reasonably practicable, taking into account the work environment and characteristics of the excavated material. In built-up areas or streets, the excavation needs to be supported to prevent collapse due to localised vehicle movement.
163. Where an employee enters a trench and there is a risk of ground collapse, the employer needs to ensure that the trench is positively supported, or be benched, battered or shielded regardless of the depth of the trench.

Tunnelling

164. A tunnel is an underground passage or opening in an approximate horizontal plane and which begins at the surface or from an excavation of any sort. [OHS Regulations r5](#)
165. The nature of tunnelling work is complex and highly specialised, and requires engineering expertise during the planning, investigation, design and construction stages.

Part 5 – Excavation methods

Design of tunnel

166. Engineering investigations and the anticipated excavation methods need to be considered in preparing a tunnel design. The design needs to include:

- details on the tunnel dimensions and allowable unsupported excavation tolerances
- temporary and final support and lining requirements for each location within the tunnel
- ventilation requirements either natural or mechanical
- details of expected tunnel drive lengths and location of shafts
- any other requirements for the finished tunnel.

167. The design should also include information on the excavation methods, ground conditions and methods of ground support which have been considered in the design.

168. The design needs to take into account the construction methods that may be used to construct the tunnel so that a safe design for construction purposes is achieved.

Tunnelling hazards and risks

169. Common hazards and risks during tunnel construction, in addition to above ground construction hazards, include:

- tunnel stability – rock or earth falls and rock bursts
- changing ground conditions – strata and stress fluctuations
- limited space and access, with possible confined spaces involved
- ventilation taking into consideration the potential for air contamination or oxygen depletion
- fire or explosion
- the use of fixed and powered mobile plant

- the interaction of people with powered mobile plant

- temporary electrical supplies and circuits, including loss of power for lighting, ventilation and pumping

- compressed air use and high pressure hydraulics

- large scale materials and equipment handling

- influxes of water, overhead seepage, ground and process water

- uneven, wet or slippery surfaces

- falling objects

- contaminated groundwater

- noise

- vibration

- heat and humidity

- use of explosives.

170. Risk controls include:

- ground support (eg pre-formed tunnel lining segments, tunnel support sets, mesh, rock bolts, and shotcrete)

- appropriate controls associated with falls from heights (for example elevating work platforms in larger tunnels)

- plant and vehicular traffic management systems

- regular plant maintenance

- pumps or dewatering systems to remove ground water

- mechanical ventilation to control airborne contaminants and air temperature or humidity

- dust extraction

- plant fitted with water scrubbers

- plant fitted with catalytic converters

- provision of breathing equipment and training in its correct use when a hazardous atmosphere is present.

Part 5 – Excavation methods

Shafts

171. A shaft is a vertical or inclined way or opening from the surface downwards or from any underground working and the dimensions of which (excluding the perimeter) are less than its depth.
172. Shafts are often constructed to provide access or ventilation to a tunnel. Shafts can also be sunk for geological investigating, constructing foundations, dewatering, and providing access to infrastructure or providing openings to underground facilities.
173. Shafts vary greatly in design and construction, depending on their purpose and the local conditions. They may be vertical or inclined, lined or unlined, various shapes, and excavated using various techniques.
174. Shaft sinking involves excavating a shaft from the top, with access and spoil removal from the top. Other construction methods include raise-boring, which is a method of constructing a shaft (or raise) where underground access has already been established. Raise-bored shafts can be from the surface or from one underground horizon to another. The method is remotely executed and does not require people to enter the shaft during operation.
175. Advice on the design and construction of shafts should be obtained from a suitably qualified person (eg an engineer) before excavation and installation. In some cases, ventilation facilities may be required. Common hazards in shaft construction include:
- shaft dimensions limiting work space, possibly including confined space work
 - underground essential services
 - the potential for ground instability
 - falls and falling objects (eg rock falls and water from the shaft wall)
 - use of hoisting equipment (eg winch, ropes and hooks)
 - water inflow or inrush and dewatering
 - airborne contaminants and ventilation
 - hazardous manual handling
 - hazardous materials
 - fire or explosion
 - inadequate communication systems
 - mobile plant
 - noise.
176. Risk controls include:
- stabilising the ground at the head of the shaft and placement of excavated material away from the top of the shaft
 - continuously lining or supporting the shaft
 - providing appropriate fall protection (for example, guard rails)
 - providing and maintaining appropriate hoisting equipment
 - installing dewatering systems
 - installing mechanical ventilation to control airborne contaminants and air temperature or humidity
 - isolating access to moving parts of plant and equipment
 - managing the working areas and temporary material placement in the bottom of the shaft
 - avoiding overfilling material kipples before lifting
 - closing shaft doors before tipping
 - cleaning the spillage off doors, stage and any steelwork.
177. Access to shaft openings needs to be controlled by using a secure cover that is lockable and accessible only by an authorised person.

Part 5 – Excavation methods

Bulk excavations

178. Bulk excavations are often undertaken when construction projects are required to make provision for large spaces (eg underground parking, basements, wetlands, or retaining basins).
179. Common hazards involved in undertaking bulk excavation work include:
- being buried from ground collapse
 - undermining the structural integrity of neighbouring structures, buildings footpaths and roadways (see paragraphs 96 to 100)
 - damage to buried essential services (for example, gas and sewerage pipes)
 - falling into the excavation or piling holes, both people and plant
 - drowning if the excavation floods from rain or damaged water or sewer pipes.
180. Before commencing bulk excavation work an employer should engage a suitably qualified person (eg a geotechnical engineer or civil engineer) to determine:
- ground conditions
 - the appropriate ground support or retention system for the site
 - suitable systems of work for the installation of the ground support system.
181. When excavating, the employer needs to ensure:
- a competent person supervises the work
 - the engineer's ground support design and systems of work is followed
 - SWMS are developed and followed for the excavation and ground support works where the work includes HRCW (see paragraphs 67 to 74)
 - employees never work ahead of the support or remove it prematurely if ground support is being progressively installed
 - employees are trained and are aware of the SWMS and emergency response procedures
 - the public is prevented from accessing the edge of the excavation or the site.
182. While the excavation remains open the excavation and site security should be inspected regularly by a suitably qualified person and as soon as possible after any event that could affect the safety of the excavation (for example, inclement weather or a ground slip).

❖ Part 6 – Reducing the risk of ground collapse

Employers must, so far as is reasonably practicable, consult with employees and HSRs, if any, on matters related to health or safety that directly affect, or are likely to directly affect them. The duty to consult applies when, for example, making decisions about risk control measures and proposing changes that may affect the health or safety of employees at the workplace. [OHS Act s35](#)
See pages 6 and 7.

183. Ground collapse is one of the primary risks to be controlled in excavation work. Ground collapse can occur quickly and without warning, giving employees virtually no time to escape, especially if the collapse is extensive.
184. Where it is determined that there is a risk of ground collapse, or where there is a possibility of the sides of the excavation becoming unstable, the excavation needs to be supported irrespective of the depth.
185. Figure 11 shows a typical example of ground failure where material collapses onto an employee pinning them against the wall of a trench. This can cause suffocation, internal organ damage, back injury or broken bones and these injuries may be fatal.
186. When planning the work and selecting appropriate excavation methods and risk controls, the employer needs to consider the following:
- the type and strength of the material to be excavated (for example, the depth of the excavation and whether the ground is self-supporting or has been previously backfilled)
 - the moisture content of the soil
 - the ground is level or sloping
 - if groundwater is present
 - if there is jointing or faults in the strata
 - if there are any other nearby water courses, drains or run-off that might affect the stability of the excavation
 - the work area and any access or operational limitations
 - the planned height of the excavated face
 - vehicular traffic or powered mobile plant will operate near the excavation
 - if there will be other construction activity nearby that may cause vibration
 - any other loads adjacent to the planned excavation (eg buildings, tanks, retaining walls, trees)
 - whether the need for persons to enter the excavation can be eliminated
 - any underground essential services (eg gas, water, sewage and electrical services).

Part 6 – Reducing the risk of ground collapse

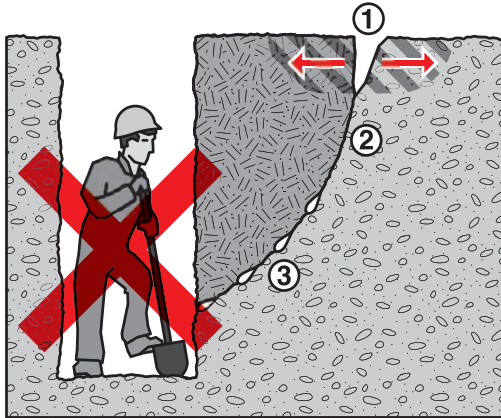

a. This is a very dangerous situation, requiring ground support. No worker should be in the trench where there is a risk of ground collapse unless support has been installed.

1. Area of tension, as wall starts to collapse.
2. Slipping plane.
3. Seepage along the slipping plane further reduces the stability of the wall. Water seeping into the excavation, tension cracks on the surface and bulging side walls are all signs of imminent collapse.

Seepage in trench bottom may not be obvious until the actual collapse.

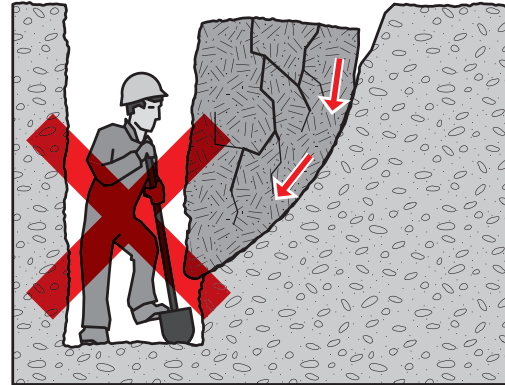

b. Shear plane failure along the seepage (slippage) lane.

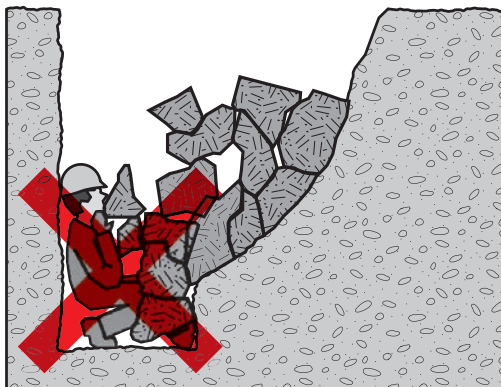

c. Worker trapped and crushed against the trench wall by the quick collapse.

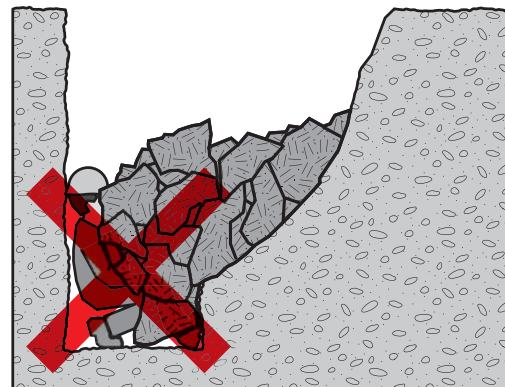

d. Worker badly injured and probably smothered after being crushed against the opposite wall by the collapsing ground. The weight of a wedge of sand over a one metre length of trench two metres deep is about three tonnes

Figure 11 – Trench collapse and associated ground forces

Part 6 – Reducing the risk of ground collapse

Ground conditions

187. The ground conditions may have a significant impact on the selection of an excavation method and the risk controls required.
188. In their natural condition, soils have varying degrees of cohesive strength and frictional resistance. Examples of materials with virtually no cohesive strength are dry sand, saturated sand and gravels with minimal clay content.
189. Ground encountered in excavations can generally be categorised as follows:
- rock
 - hard, compact soil
 - dry soil liable to crack or crumble
 - loose or running material.
190. Hard compact soil is the type that can cause the most trouble because the face 'looks good' and this often leads to risks being taken. Loose or running material is often the safest, because the need for safety precautions is obvious from the start.
191. An employer needs to give careful consideration to soil liable to crack or crumble or sandy conditions before determining appropriate risk controls. With the right amount of moisture ground conditions can look safe and solid. The loss of a small amount of water can make the soil crumble or an increase in water content can make the soil or sand slump.
192. The following examples can increase soil stresses in an excavation and may lead to failure under adverse weather conditions, additional load or vibration:
- excavation, by removal of support previously provided for the excavated material
 - loads on the ground surface near the top of the excavation, such as excavated material, digging equipment or other construction plant and material
 - shock and vibration, which could be caused by, digging equipment, passing loads or vibration producing plant (for example, compactors)
 - water pressure from ground water flow, which fills cracks in the soil, increases horizontal stresses and increase the possibility of slumping
 - saturation of soil, which increases the weight and in some cases the volume of the soil.
193. The following examples may reduce soil stability:
- excess water pressure in sandy soil may saturate the soil and increase its plasticity
 - dryness of the soil may reduce cohesion in sandy soil and soils high in organic content which then may crumble
 - prolonged stress may cause plastic deformation (for example, by squeezing)
 - prolonged inactivity at an excavation site. An evaluation of the soil should be undertaken before work recommences.
194. Before commencing work, an employer needs to obtain as much information as possible about the ground conditions. Natural features such as rock outcrops, water courses, creeks and swamps should be inspected. The surface drainage system should also be studied in relation to the line of the proposed excavation.
195. Information on ground conditions may be available from nearby works such as existing railway cuttings, roadways and foundation works. Results of test bores are usually available from relevant authorities. When test bores are not available, unsupported test excavations using a backhoe should be dug in areas where ground conditions are unclear. The ground conditions should then be assessed to determine suitable ground supports.

Part 6 – Reducing the risk of ground collapse

196. Additional care needs to be taken where disturbed ground may exist due to previously worked trenches or shafts (see Figures 12a – 12e). In such cases, it is essential to increase the excavation ground supports or use a correctly designed and fabricated trench shields.

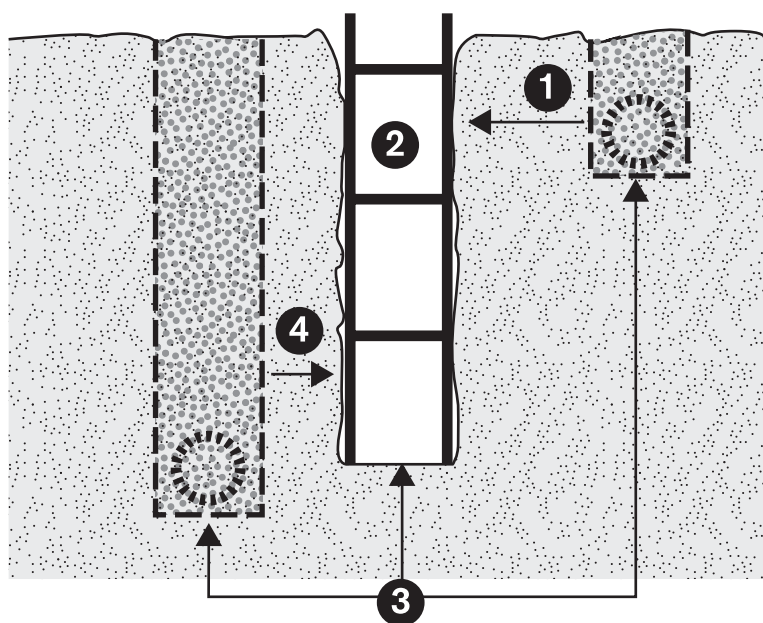

a.
Sectional view of old and new excavation.

Old excavation may be waterlogged or the fill may not have consolidated. Where only a relatively thin wall of undisturbed material separates the two excavations, this barrier may be under increased side pressure and, therefore, more likely to collapse.

1. Side pressure from higher pipe
2. Current open excavation
3. Trench depths may differ
4. Side pressure from thin section of undisturbed wall.

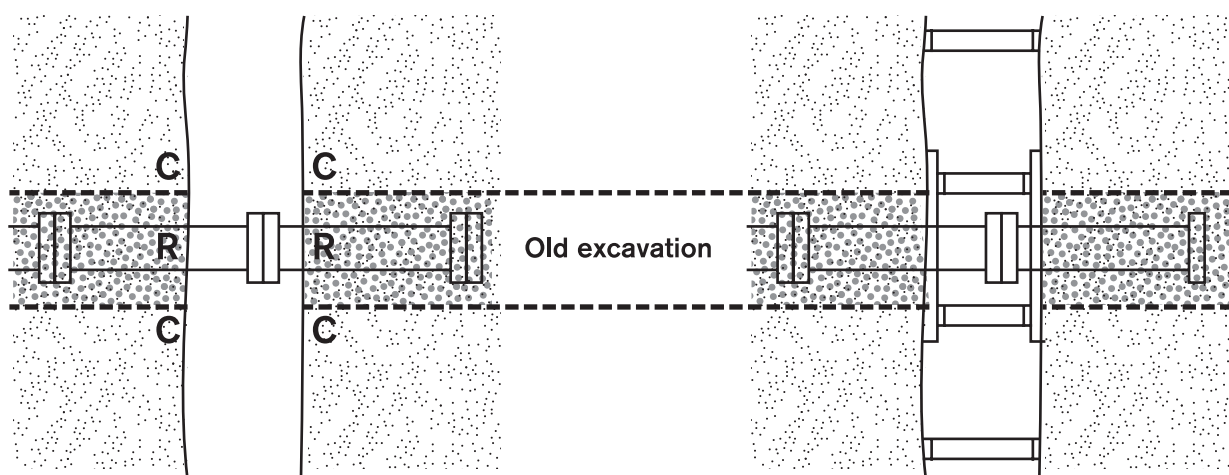

b.
Four separate corners (C) of undisturbed material may be created, and the refill (R) in the older excavation may present a further hazard if the refill is waterlogged or comprised of unconsolidated material. This junction should be close lagged horizontally, or close sheeted vertically.

c.
Correctly located ground support (shoring), supporting corner of intersection, and the old refill using closed horizontal lagging or closed vertical sheeting.

Part 6 – Reducing the risk of ground collapse

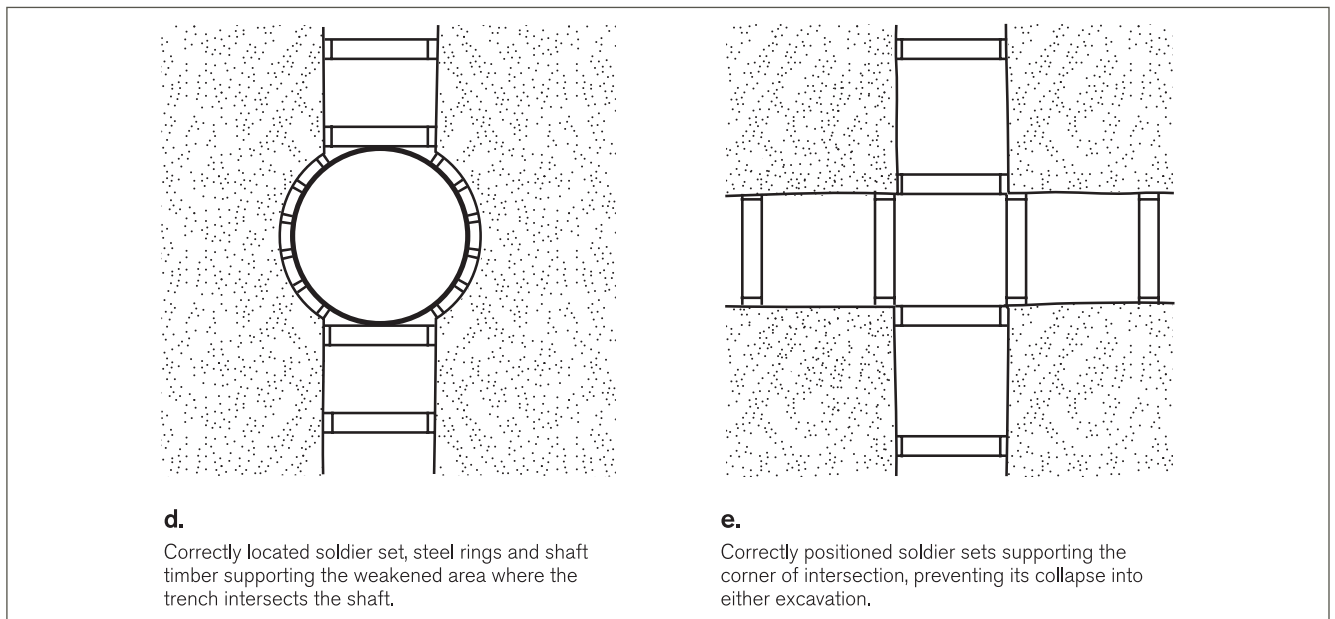

Figure 12 – Working close to disturbed ground

Controlling the risk of ground collapse

197. There are three main types of ground collapse risk controls that can be used where ground collapse may occur:

- **trench shields**
- **benching or battering**
- **positive ground support (for example, shoring).**

198. An employer needs to ensure that the selected method of ground support is installed safely and as soon as possible after the ground has been excavated.

199. There is a difference between a ground support system and a shield. A ground support system supports the sides of an excavation, preventing collapse and ensuring the safety of employees. Unless backfilled between the trench wall and the shield, a shield will not support the ground, but does protect the people inside the shield if the wall collapses.

200. An employer needs to ensure that all ground support systems, including shoring and trench shields, are regularly inspected. This is particularly important when an excavation enters different ground conditions or is subject to heavy rains or flooding. Ground supports need to be inspected, repaired and reinforced as necessary.

201. Some specific areas of the excavation may not require shoring, benching or battering if written analysis is received from a suitably qualified person (eg a geotechnical engineer) that identifies which specific sections of the excavation are safe from collapse. Any analysis should state the period of time to which it applies and should identify which occurrences may create a risk of ground collapse (eg rain, increase loads for plant or spoil piles, vibration).

Part 6 – Reducing the risk of ground collapse

202. If excavation work is planned to be carried out without positive ground support, the continuing safety of the excavation will depend on the conditions arising during construction. If the conditions during construction are not as expected, or if conditions change during the course of the work (eg different soils, heavy rain or flooding) an employer needs to ensure that action is taken immediately to protect employees and other people by implementing appropriate risk controls, such as suspending work until the ground is stable or by installing a positive ground support system.

Trench shields

203. Trench shields are commonly used during trenching works to protect employees from being engulfed by a ground collapse. Trench shields come in a variety of shapes and sizes and generally consist of steel or aluminium panels. The panels are held apart by struts at both ends and secured into position by pins and clips or welded. Trench shields are designed to be repositioned as the trench work progresses and the finished section of trench is back filled. Figure 13 shows a typical trench shield.

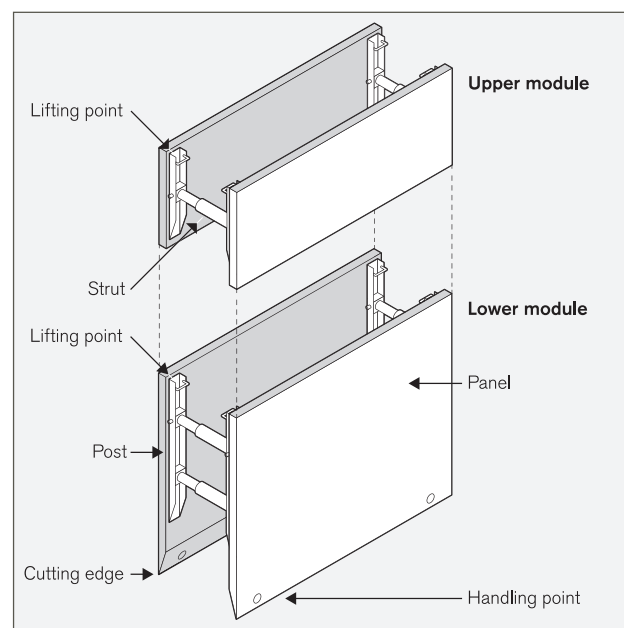

Figure 13 – Typical trench shield

Part 6 – Reducing the risk of ground collapse

204. Trench shields are designed and constructed to withstand impact from ground collapse or the earth pressures if the ground becomes unstable. They incorporate certified lifting points for installation and removal. The trench shield needs to also be firmly wedged into the ground to prevent it from moving if struck by collapsing ground or the area between the shield and trench wall needs to be backfilled with suitable material. An employer needs to ensure that the design of trench shields is carried out by a suitably qualified person (for example, engineers experienced in trench shield design). A trench shield may be pre-manufactured to job specific dimensions.
205. Employers must maintain plant, so far as is reasonably practicable, so it is safe and without risks to health **Section 21(2)(a) OHS Act** For example, trench shields need to be adequately maintained or they may fail unexpectedly, particularly if they have been damaged and not properly repaired. The manufacturer's instructions for the installation, use, removal, maintenance and inspection of trench shields need to be followed.
206. Trench shields are mainly used in open areas where access is available for an excavator or backhoe to lower and raise the trench shields into and out of a trench. They are generally not suitable where access is difficult and ground conditions prevent the use of lifting equipment.
207. Trench shields can be used as ground support systems if they are of a similar width to the excavator bucket and can be placed in the excavation and pressed down. This ensures that the trench shields provide firm support to the trench wall. In the absence of ground support, the only safe area in the trench is that which is actually protected by the shield.
208. When selecting the correct trench shield, the conditions of the environment in which the equipment is to be used need to be considered, including:
- the nature of the soil, including the type, moisture content and water table (for example, the level below which the ground is saturated with water)
 - ground stability and any anticipated ground vibration (for example, from nearby machinery or road traffic)
 - expected ground pressures, including the location of the spoil pile and equipment to be used
 - the size of the trench or excavation (for example, the depth, width and length)
 - any space constraints
 - the existence or proximity of underground services
 - the type of road traffic and plant near the site, and
 - the system of work to be used with equipment.
209. When trench shields are used as the only means of ensuring safety in the trench, an employer needs to ensure that employees do not:
- enter the excavation prior to installation of the shield
 - work inside a trench outside the protection of a shield
 - enter the excavation after the trench shields have been removed
 - enter a shield other than by a suitably designed means (for example, a trench bridge with ladder mounting point should be considered where appropriate).

Part 6 – Reducing the risk of ground collapse

210. The ideal placement for a trench shield is when it rests on the bottom of the excavation and extends above the surface by at least 900mm, as it also provides fall protection (see Figure 14). An alternative method is narrowing the bottom of the trench and having the trench shield supported. When this method is used the trench shield needs to be tightly wedged into the trench (see Figure 15).

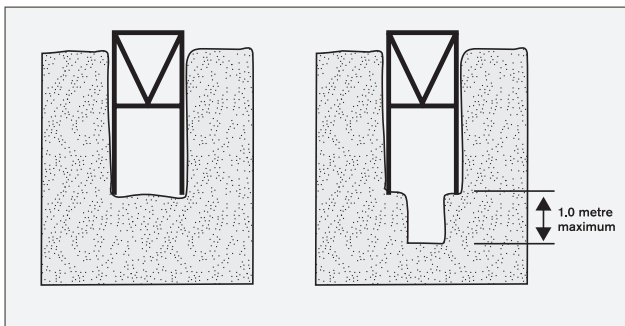

Figures 14 and 15 – Ideal placement for trench shield and an alternative method for trench shield placement

211. Trench shields should not be subjected to loads exceeding those for which the system was designed to withstand. Earth pressures are reduced when correct benching and battering practices are used. Figure 16 provides an example of a trench shield placed in a slope battered trench and Figure 17 provides as an example of a trench shield placed in a step battered trench.

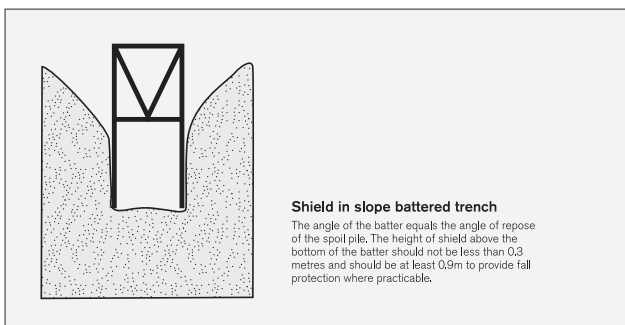

Figure 16 – Shield in slope battered trench

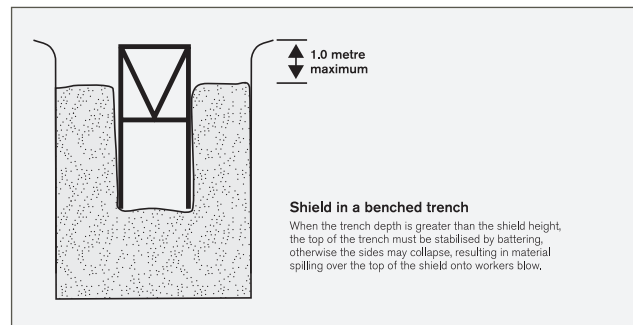

Figure 17 – Shield in a benched trench

212. In some circumstances (for example, when digging in rocky ground) it may be difficult to excavate smooth sided trench walls that allows for the trench shield to fit tightly. This can result in the creation of large voids between the trench shield and the trench wall, which allows sections of the trench wall behind the shield to collapse. This additional risk can be controlled by excavating the trench with walls closer to vertical, or pushing trench spoil or backfill material into the void area.
213. Trench shields are often lifted, lowered, extracted and moved around a worksite using earth moving equipment. If a suspended load is not controlled there may be a risk of a load falling from height, or swinging unexpectedly.
214. Where trench shields are to be suspended by chains or wire rope slings, the employer needs to ensure that sling hooks are attached to purpose-designed lifting points in a manner that requires a deliberate action to release the connection (for example, a self-locking hook or hook with latch). Connections that rely on gravity alone (ie open hooks) should be avoided as they may dislodge due to the movement of the lifting equipment or load.

Part 6 – Reducing the risk of ground collapse

215. An employer needs to ensure that trench shields are controlled at all times while being lifted or suspended. The installation and removal of trench shields needs to be undertaken by an appropriately qualified plant operator and, where appropriate, a licensed dogger or rigger.
216. Trench shields are often assembled and dismantled on site. If the process is not undertaken correctly the trench shield components may become unstable and collapse, placing employees at risk of being struck by the collapsing shield. Prior to undertaking assembly or dismantling activities, the employer needs to ensure that a safe system of work is developed in accordance with the manufacturer's instructions.
217. The use of trench shields provides a means of safely accessing the trench when joining pipes or traversing disturbed or unstable ground.
218. Trench shields should be stored and transported in accordance with the manufacturer's instructions. Large dimensional trench shields may require disassembly prior to transport.

Benching and battering

219. Benching or battering creates excavated steps or slopes which should provide appropriate control from ground collapse. That is, the steps or slope will not slump when left for a considerable period, there will be no movement of material down the slope and the toe of the slope will remain stable.
220. **Benching** is the creation of a series of steps in the vertical wall of an excavation to reduce the wall height and improves stability (see Figure 18). Benching is a method aimed at reducing the risk of ground collapse by excavating the sides of an excavation to form one or more horizontal levels or steps with vertical surfaces between levels.

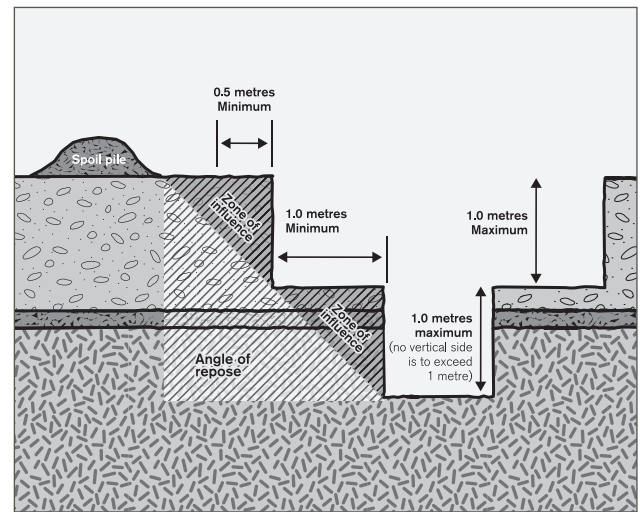

Figure 18 – Benching

221. **Battering** is where the wall of an excavation is sloped back to a predetermined angle to improve stability (see Figure 19). Battering reduces the risk of ground collapse by cutting the excavated face back to a safe slope. Battering needs to commence from the bottom of the excavation. In some circumstances it may be appropriate to use a combination of benching and battering on an excavation (see Figure 20). The angle of repose needs to take into consideration all inclement weather.

Part 6 – Reducing the risk of ground collapse

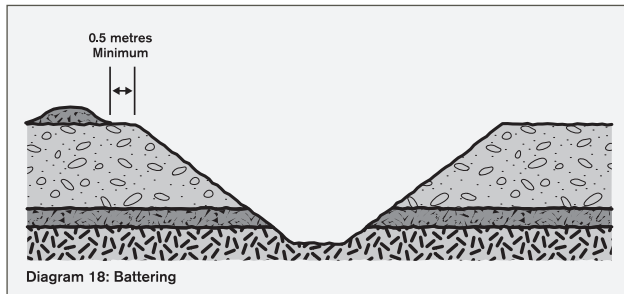

Figure 19 – Battering

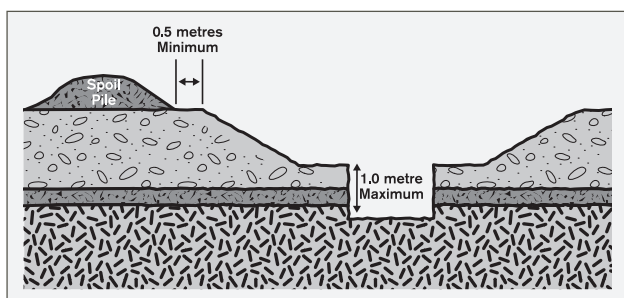

Figure 20 – Combination of benching and battering controls

222. Benching and battering of excavation walls can minimise the risk of soil or rock slipping into the excavation. An employer needs to ensure that risk controls are designed by a suitably qualified person (for example, a geotechnical engineer) and be relative to the soil type, the moisture content of the soil, the planned height of the excavated face and any additional loads acting on the excavated face.
223. It may not be necessary to bench or batter the face of excavations which a geotechnical engineer determines are in stable rock or has assessed that there is no risk of collapse. The geotechnical engineer should provide the assessment or determination in writing.
224. Sides of the excavated face should be battered to the angle of repose (see paragraph 114) of the soil pile. If it is proposed to have a battered angle higher than the angle of repose of the spoil pile, a geotechnical analysis needs to be undertaken and documented before excavation work commences.
225. Benches need to be wide enough to stabilise the slopes and to prevent material from the top falling into the working area.
226. The size and type of any earthmoving machinery to be used and any related haulage removal routes need to be considered when designing the batters and widths of benches.

Part 6 – Reducing the risk of ground collapse

Shoring

227. Shoring is a positive ground support system that can be used when the ground conditions, location or depth of an excavation makes battering or benching impracticable (for example, unstable ground conditions such as excavating sand, silt or clay). It provides support for excavated faces, preventing movement of the excavation sides that can lead to ground collapse. Shoring needs to be designed by a structural or geotechnical engineer for the specific workplace ground conditions.

228. Some common types of shoring are:

- closed sheeting
- plywood panels (sandwich sheets), and
- soldier sets (hydraulic and timber).

229. The use of metal shoring has largely replaced timber shoring because of its ability to ensure even distribution of pressure along an excavation line and it is easily adapted to various depths and excavation widths.

230. Stabilising the face of an excavation should progress as the excavation work progresses. If any part of the excavation is left unstable or unsupported, the employer needs to ensure that appropriate risk controls are put in place to prevent employees or others entering the area (see Figure 21).

231. The employer needs to ensure that employees do not enter any part of the excavation that is not protected unless it is safe, and that employees do not work ahead of the shoring protection that is being progressively installed.

232. Where there is a risk of ground collapse during the installation and removal of shoring, the employer needs to ensure that systems of work and ground collapse control systems are in place to ensure the health and safety of employees entering or working in the excavation (see paragraphs 253 to 263).



Figure 21 – In an excavation requiring ground support, workers should not enter an unsupported section

Part 6 – Reducing the risk of ground collapse

Closed sheeting

233. Closed sheeting (see Figure 22) is a continuous frame where vertical timber or metal sheathing planks are placed side by side to form a continuous retaining wall to fully cover and support an excavated wall. The closed sheet may also be supported by the other members of the ground support system such as toms and walers.

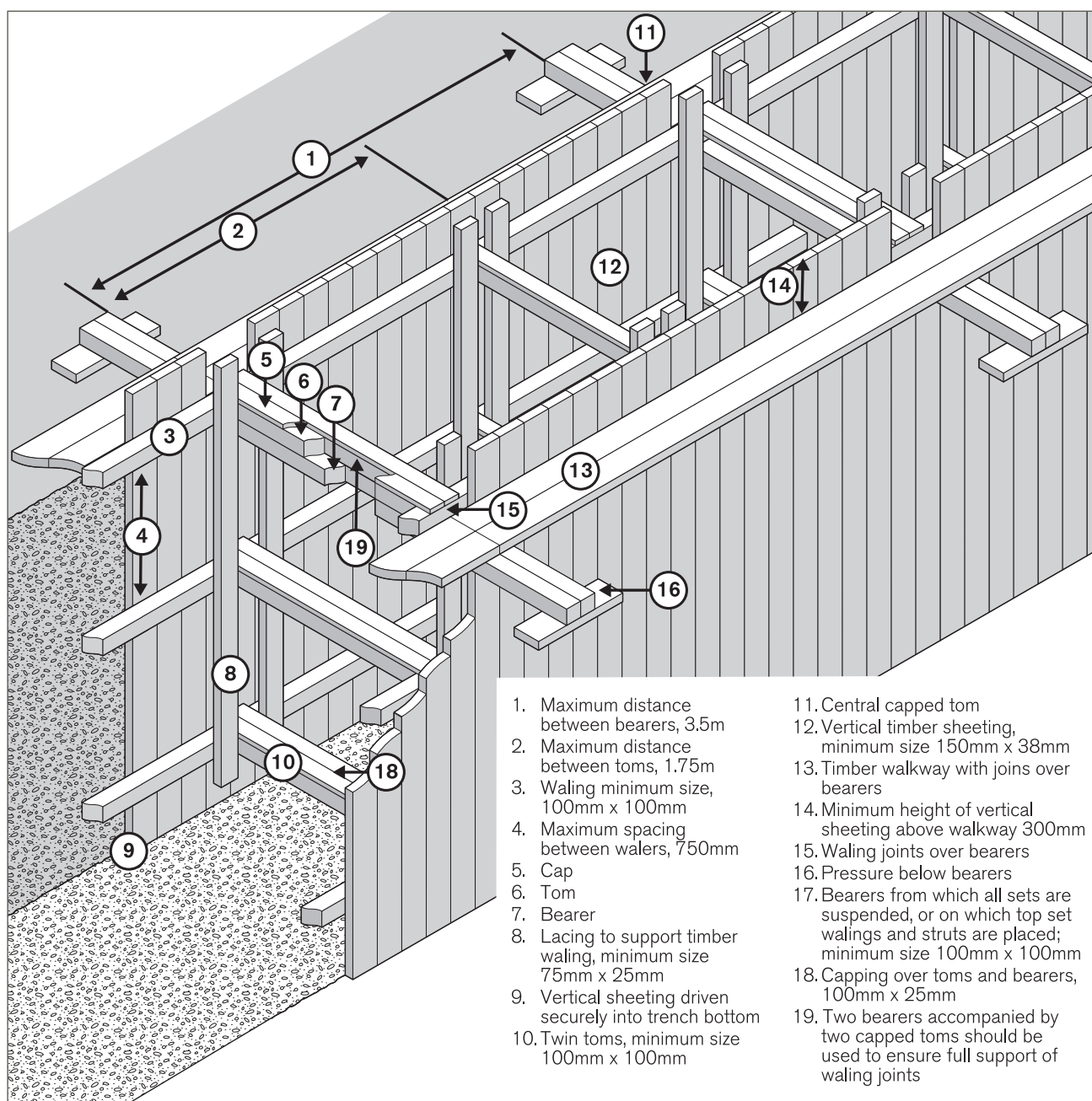

Figure 22 – Example of closed sheeting

Part 6 – Reducing the risk of ground collapse

234. This method of ground support is used when unstable ground conditions (such as sand) are encountered (for example, when there is a danger of the ground running or collapsing). An employer needs to ensure that walers and toms are installed as soon as reasonably practicable during the excavation process, followed by the insertion of the closed sheeting. When using this method of excavation, capping over the toms needs to extend the full width of the excavation, as they support the timber toms on the waling (see Figure 25).
235. Bearers are used to support the collar set of toms and walers. To ensure that the walers are correctly located, timbers called 'lacing' need to be secured to the walers.

Shoring terms

Tom is a structural member used to hold soldiers against an excavation wall or to press walers apart when closed sheeting or panels are used.

Waler is a horizontal steel or timber element which supports vertical elements such as soldiers, sheeting and panels.

Soldier is a vertical upright timber or steel element used for supporting an excavation wall.

Strut or screw jack is a timber or steel member (usually horizontal) in compression, resisting thrust or pressure from the face or faces of an excavation. Screw jack struts are adjustable.

Side lacing

236. Side lacing is a form of closed sheeting used primarily to ensure safety by preventing soil from slipping by the placement of fill behind timber boards or steel plates (see Figure 23). Side lacing is used in all types of ground, and is particularly useful where long or large diameter pipes are to be installed and in variable ground conditions where steel or timber supports are difficult to install. Side lacing needs to be firmly wedged into the ground to prevent it from moving when fill is placed against it.

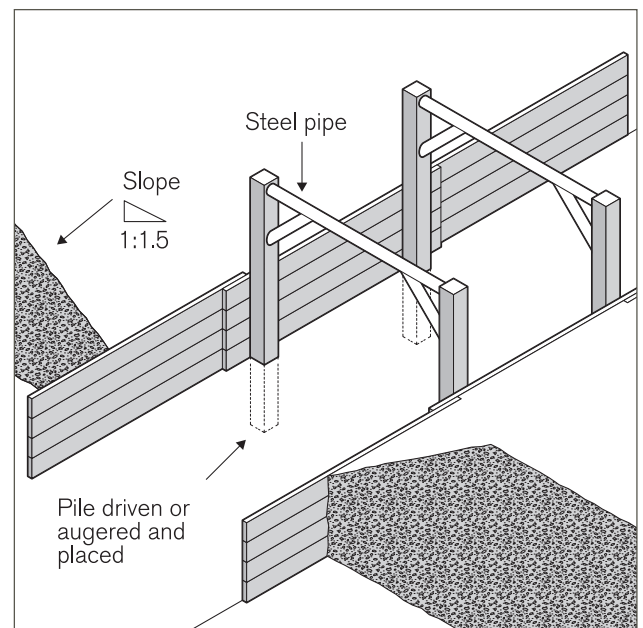

Figure 23 – Side lacing in sand trench

237. When closed sheeting or side lacing is used to prevent ground collapse, an employer needs to ensure that employees do not:
- enter the excavation prior to the installation of the sheeting or lacing
 - work inside an excavation, outside the protection of sheeting or lacing
 - enter the excavation after sheeting has been removed
 - enter an area where there is sheeting or lacing, other than by a ladder.

Part 6 – Reducing the risk of ground collapse

Steel sheet piling

238. Steel sheet piling is a form of closed sheeting which generally used on major excavations such as large building foundations or where large embankments are to be held back and can be installed prior to excavation work commencing. It is also used where an excavation is in close proximity to adjoining buildings (see Figure 24).

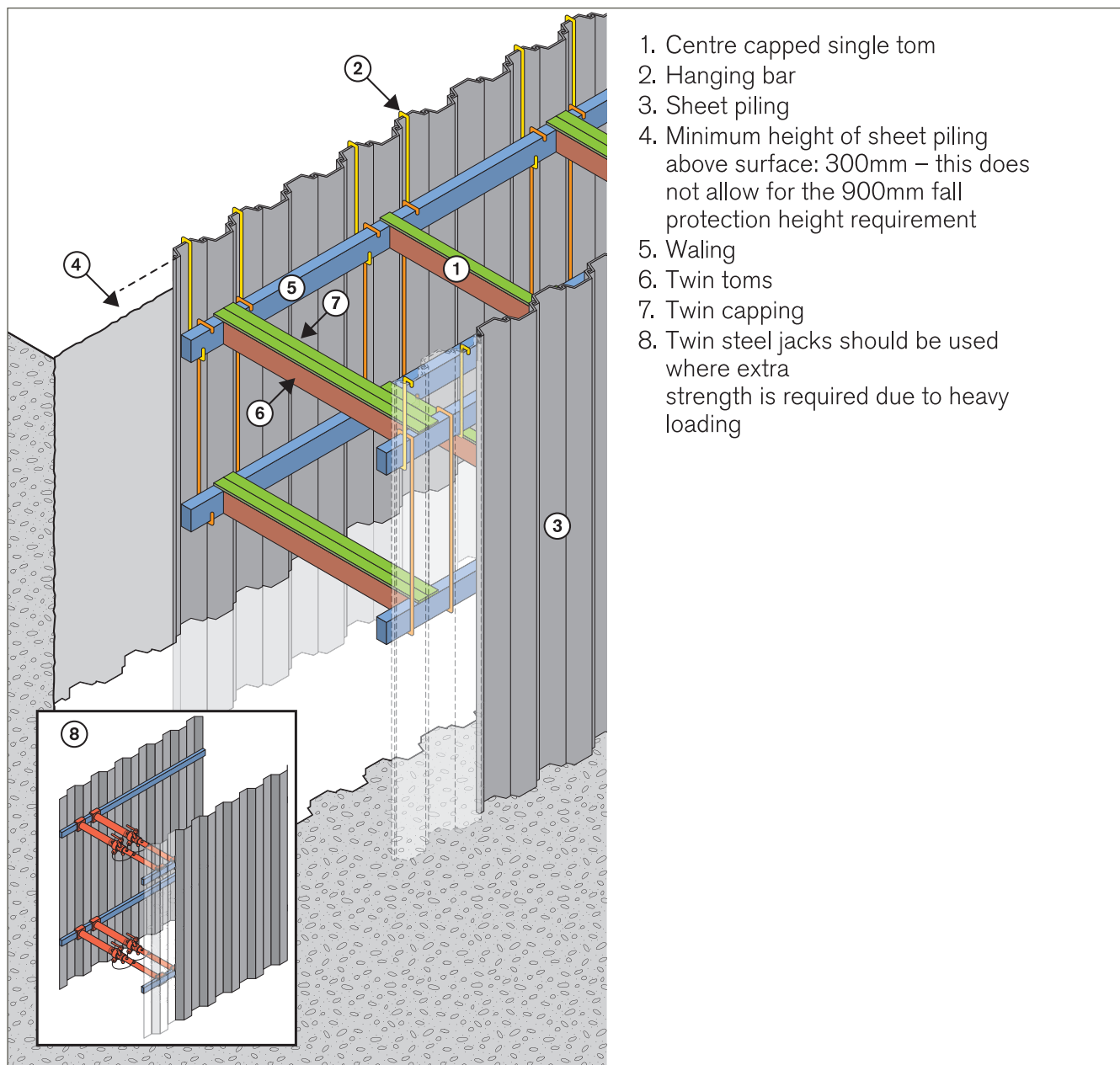

Figure 24 – Steel sheet piling

Part 6 – Reducing the risk of ground collapse

239. Steel sheet piling should be used when the ground is so unstable that side wall collapse is likely to occur during excavation (for example, in loose and running sand). In such cases, an employer needs to ensure that sheet piling is installed before excavation commences.
240. It is positioned and mechanically driven in to final depth. Toms and walings are placed into position as the soil is excavated. Although timber can be used, it is more efficient to use adjustable jacks or struts (see Figure 25).

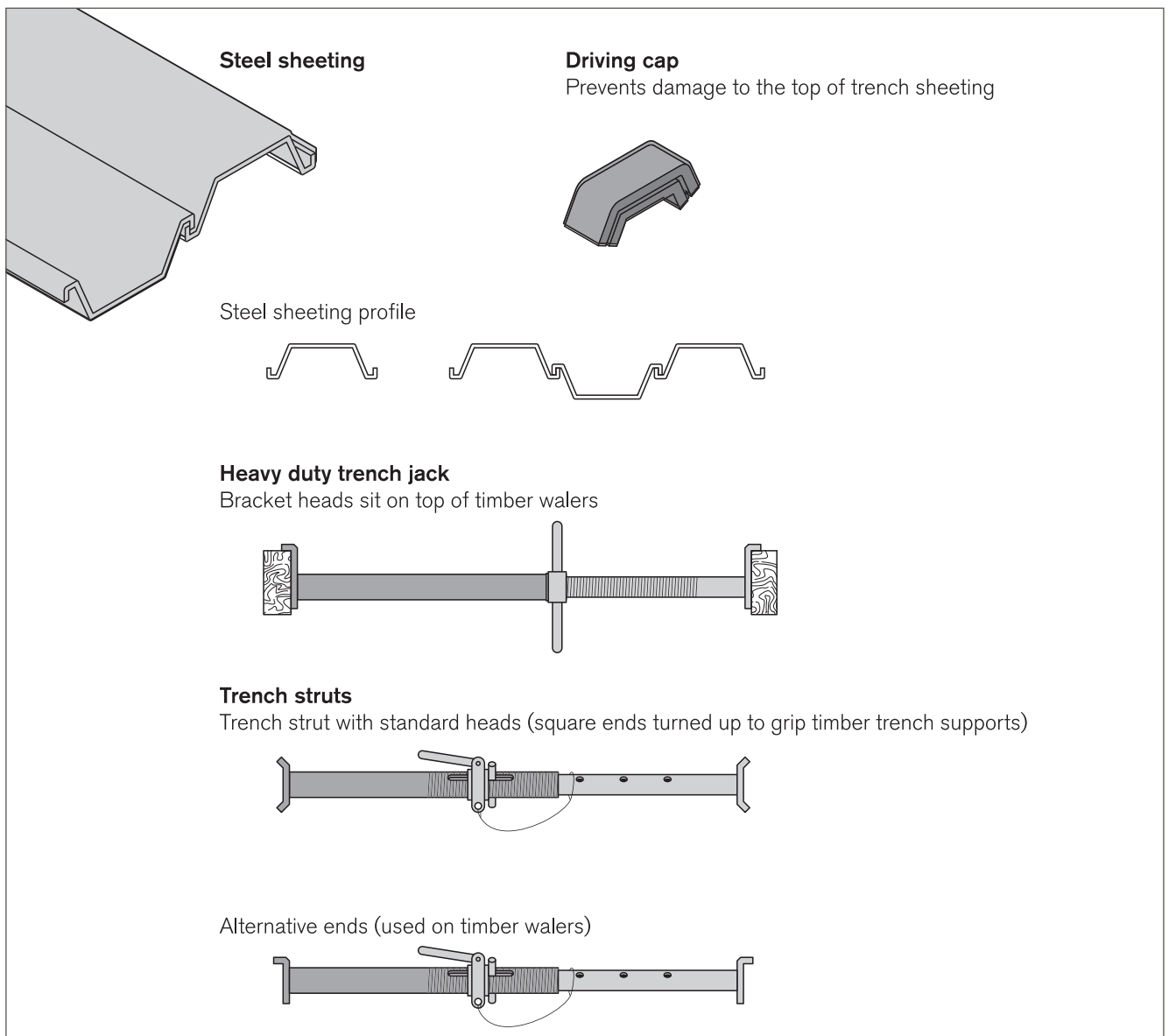

Figure 25 – Steel trench sheeting and jacks

Part 6 – Reducing the risk of ground collapse

- 241. Steel sheet piling is heavier weight than closed sheeting and in some circumstances may be driven by hand-held pneumatic hammers or electrical operated vibrating hammers. Any hazardous manual handling arising from these tasks needs to be controlled. Any projections on the underside of the anvil of jack hammers need to be removed to prevent damage to the driving cap and potential injury to the operator.
- 242. Employees may be exposed to noise levels in excess of the noise exposure standard due to driving operation, so the employer needs to ensure risks associated with exposure to noise are controlled.
- 243. For more information about controlling the risk of noise exposure see the *Noise compliance code*, and for guidance on hazardous manual handling, see the *Hazardous manual handling compliance code*. Both Codes are available at worksafe.vic.gov.au.

Plywood panels (sandwich sheets)

- 244. Plywood panels (sandwich sheets) should be used in variable ground conditions. In unstable ground, the panelling needs to be continuous (closed sheeting). The panelling and soldiers need to be pressed firmly against the excavation sides by either expanding the steel jacks (see Figure 25) or cutting toms of appropriate length and forcing them in place.
- 245. Timber tongs are used to lower the tom into the excavation with the lower end of the tom being placed on top of the far side bottom cleat. The upper end of the tom is then placed against the opposite soldier, above the near side bottom cleat. This upper end is finally driven down onto the bottom cleat causing the lower section of the two soldiers to press against the excavation.

Soldier set systems

- 246. The soldier set system is a simple form of excavation support which can be formed with steel or timber. This system is mostly used in rock, stiff clays and in other soil types with similar self-supporting properties.
- 247. Unlike closed sheeting, soldier sets retain the earth and may be increased in an area where there is a fault in the embankment. Soldier sets only provide ground support at regular intervals and do not provide positive ground support between the sets. Open soldier sets should only be used in stable soil types.
- 248. Figure 26 shows the minimum support required for a trench being driven through ground of compact, stiff clays, or other sediments. These support dimensions need to be increased in trenches wider than one metre, or where the supports show signs of being overloaded, or where there is evidence or a likelihood of the trench becoming unstable between sets.

Part 6 – Reducing the risk of ground collapse

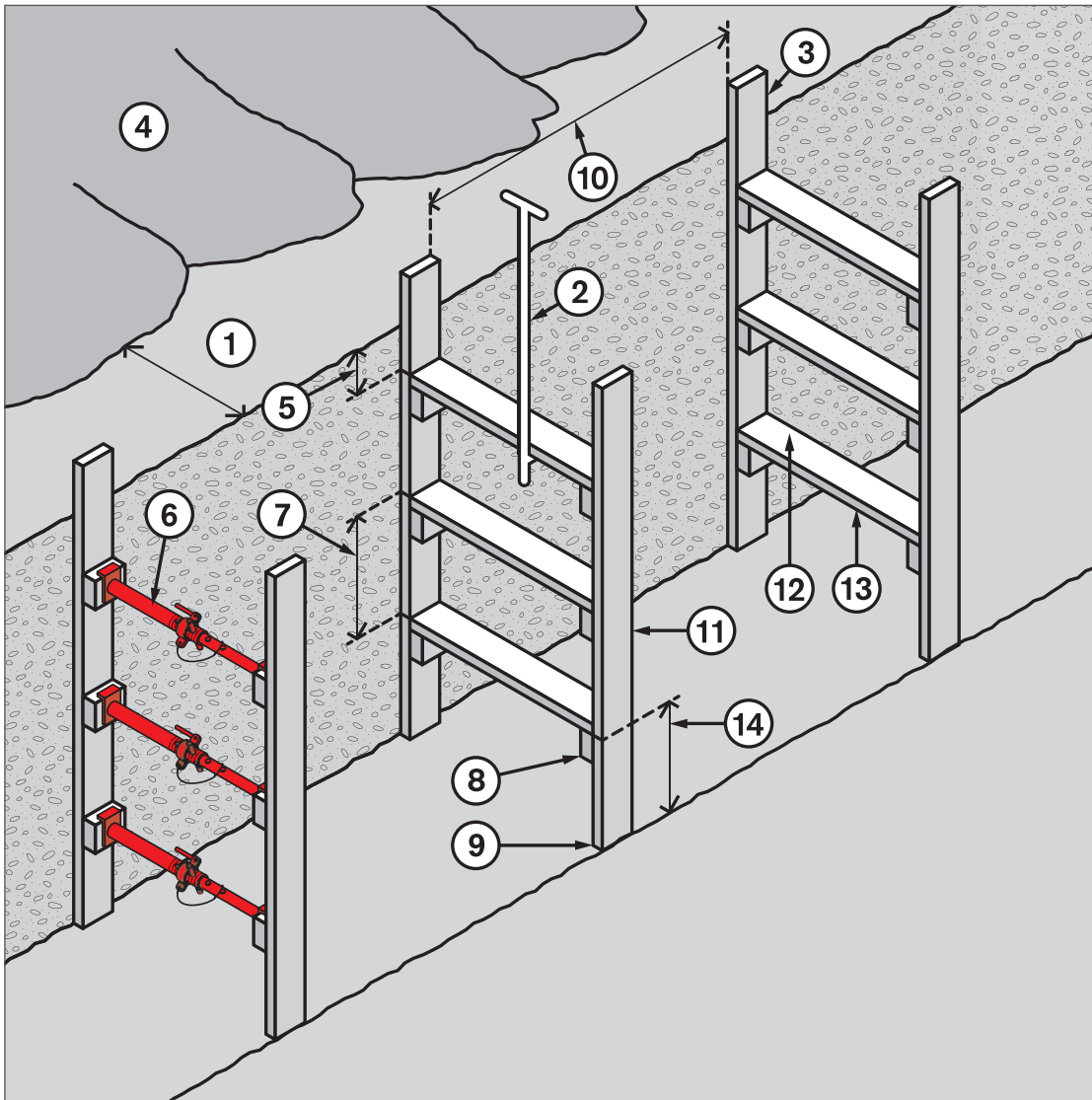

1. Spoil heap at least 500mm clear of excavation allows access along both sides of the trench top and prevents material from the heap rolling into the trench.
2. Toms placed from surface with special timbering tongs.
3. Soldiers protrude 500mm above the top of the trench.
4. Spoil heap or pile.
5. Top tom no lower than 300mm from the trench top.
6. For added side support, steel jacks may replace timber toms.
7. Maximum spacing of toms no more than 750mm.
8. Cleats securely nailed to soldiers before placing soldiers in trench.
9. Soldier resting securely on trench bottom.
10. Maximum spacing between soldier sets 1.5 metres.
11. Soldier.
12. Tom.
13. Tom should be long enough to force soldiers firmly against trench sides. To prevent excessive bowing of soldiers against irregular trench sides, wood packing, between the trench wall and the soldier, may be used
14. Space between the bottom tom and trench floor should be sufficient to allow installation of a pipe – normally, no more than 1 metre.

Figure 26 – Timber soldier sets

Part 6 – Reducing the risk of ground collapse

Hydraulic systems

249. Hydraulic support systems are mainly used to provide temporary or mobile ground support while other ground supports are being installed (see Figure 27).
250. An employer needs to consider ground pressures prior to installing hydraulic supports. The hydraulic support system needs to be designed by a geotechnical engineer. The hydraulic capacity of the ground support system needs to be designed to resist the expected ground pressures and potential for collapse.
251. Hydraulic support systems may become unreliable or rupture if not properly maintained and properly used. Frequent inspections of pressure hoses and rams are necessary by appropriately qualified persons to detect abrasion, fatigue or damage such as bent or notched rams. Hydraulic systems need to incorporate hose burst protection.
252. An employer needs to ensure that, upon removal from the excavation, hydraulic supports are inspected, repaired if necessary and carefully stored prior to re-use.

Part 6 – Reducing the risk of ground collapse

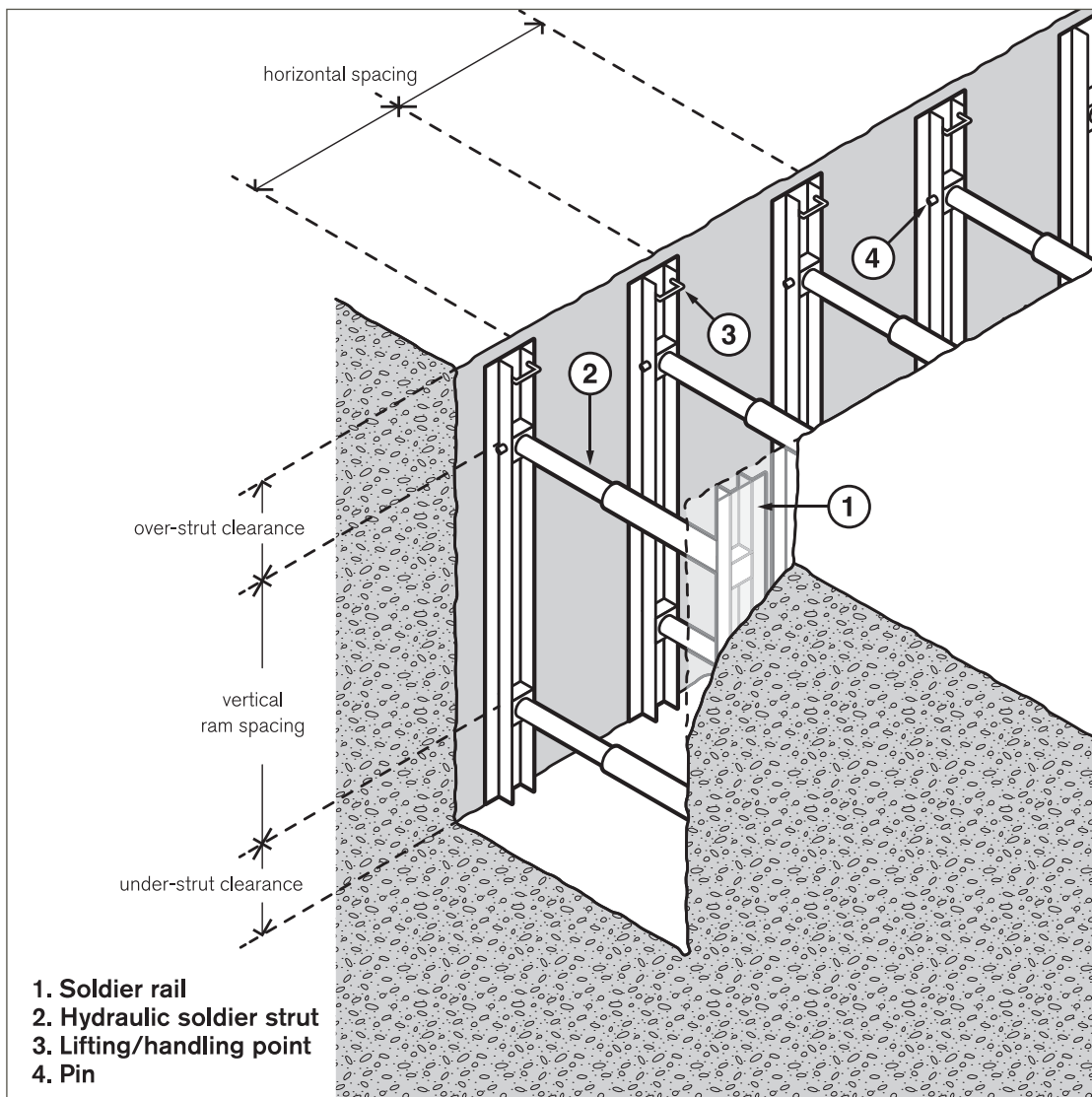

Figure 27 – Hydraulic shoring (soldier set style)

Installing and removing ground support systems

253. An excavated area is most insecure when the ground supports are being installed or removed. An employer needs to ensure that all support systems are installed and removed in a manner that protects employees from ground collapse, structural collapse or being struck by structural members. Before installation or removal begins, temporary structural supports should be installed to ensure work can be done safely.

254. Work should not proceed in potentially unstable, unsupported ground. Work can only proceed in potentially unstable ground if appropriate stabilising and supporting structures are correctly implemented. Working without installing supports may hasten the excavation process, but a substantial ground collapse may delay operations.

Part 6 – Reducing the risk of ground collapse

Installing ground support systems

- 255. During the erection of support systems, as more material is excavated the ability of the walls to support the load may decrease.
- 256. If employees are required to enter an excavated area before permanent supports have been correctly installed (for example, to drill and place explosives), the employer needs to ensure that temporary protection in the form of timber supports or trench shields is used to protect the employees from ground collapse or falling rocks.

Removing ground support systems

- 257. An employer needs to ensure that ground support is not removed from the section of an excavation where employees are working. Ground support systems should only be removed using a predetermined safe method under the direction of a person with the appropriate expertise. The support material should be left in place if its removal is dangerous.
- 258. When a ground support system is being dismantled and the excavation has not been properly backfilled, the excavated area may not withstand the increase side pressure that was previously borne by the ground supports. This may cause the excavated area to collapse.
- 259. Removal of the soldier sets needs to be done from the surface or from a supported area of the excavation area. There are two recommended methods of removal, both of which require employees to be in the excavated area during dismantling. Consideration should be given to compaction of backfill material as the work progresses.

- 260. **Method 1** – This is the preferred method (see **Figures 28a and 28b**). Soil needs to be replaced back into the excavated area along the entire length so that it is level with the bottom set of toms prior to employees entering the excavation. Once this is complete employees can then enter the excavated area and remove all the bottom toms. Once this is complete employees need to leave the excavation so it can be back filled to the next level of toms. The next level of toms then needs to be removed in the same way. This is repeated until all the toms have been recovered, after which it is safe to remove the soldier sets by means of back-hoe and chains or lifting lug. Backfilling is then completed.

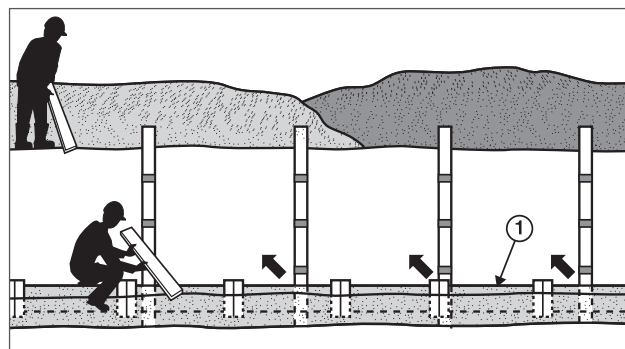

Figure 28a – Removing soldier set ground supports, method 1

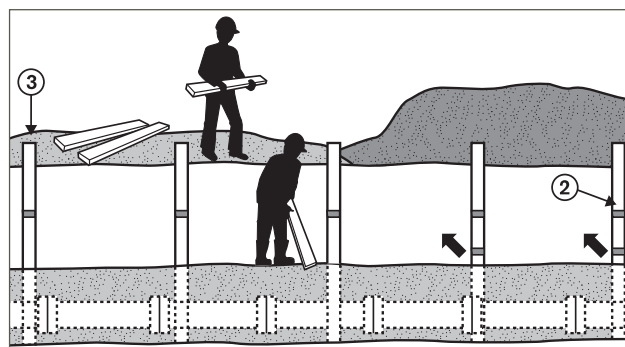

Figure 28b – Removing soldier set ground supports, method 1

Part 6 – Reducing the risk of ground collapse

261. **Method 2** – With this method (see **Figures 29a and 29b**), backfilling progresses from one end of the excavation to the other. This is useful practice when the excavation has restricted access.
262. Backfill is placed in the excavation until it begins to run over the bottom tom of the first soldier set. An employee then removes the bottom tom. Once this is complete the employee needs to leave the excavation or go behind a complete soldier set. This is because if ground does fall it may collapse back to the last complete set. More back fill is then added until it reaches the next tom in the set being recovered. This is repeated until all toms in the soldier set are removed.
263. The two soldier sets are then removed and the excavation is backfilled until the fill reaches the bottom tom of the next set. The process is repeated along the whole length of the excavation.

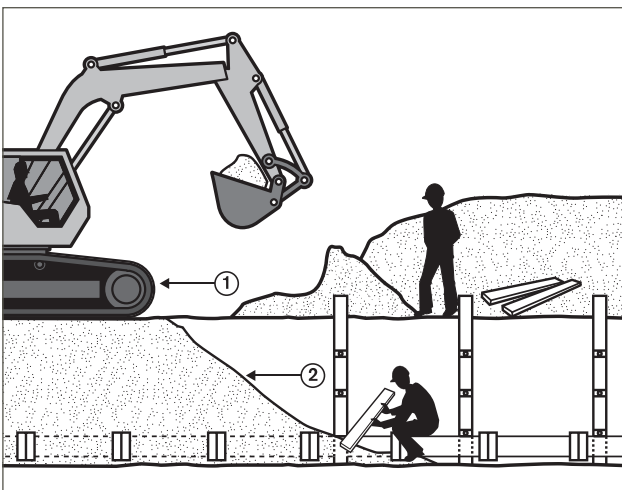

Figure 29a – Removing soldier set ground supports, method 2

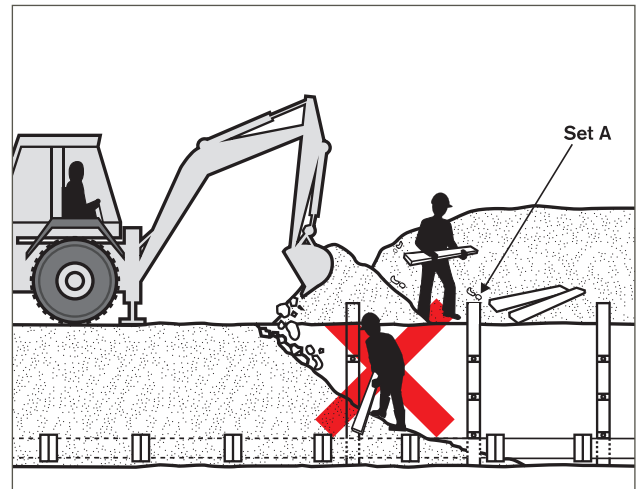

Figure 29b – Removing soldier set ground supports, method 2

264. Soldier sets should not be used to enter or leave an excavated area (see Figure 26). Ladders or other appropriately designed means need to be used. An employer needs to ensure safe access is provided in all excavation where work is being undertaken.
265. Using toms as a ladder is unsafe as the excavation wall may have shifted, thereby loosening the top tom, or the soldier set may have been erected incorrectly. Soldier sets could become damaged and weakened if used as a ladder which may cause the soldier set to fail and the excavation to collapse.

Part 6 – Reducing the risk of ground collapse



Figure 30 – Unsafe form of access

Regular inspection

266. The condition of soil surrounding excavations can change quickly due to the soil drying out, changes in the water table or water saturation of the soil. An employer needs to ensure that the soil condition and the state of shoring, battering and excavation walls is frequently checked by a suitably qualified person for signs of earth fretting, slipping, slumping or ground swelling. Where necessary, the employer needs to ensure the excavation is repaired or the shoring system is strengthened from above before allowing work within the excavation to recommence.
267. Risk controls must be monitored, reviewed and (if necessary) revised (see paragraphs 55 to 59). In the course of daily routine inspections, the person with the management or control of the excavation site should look out for unsafe situations during excavation, pipe laying and backfilling. Inspection of excavation walls and support systems needs to be carried out frequently to ensure:

- the sides of the excavation are not being undercut by the excavator bucket
 - the supports have not been damaged
 - supports are not being overstressed as evidenced by bowing or creaking
 - the ground is not fretting or beginning to collapse into the excavated area which may:
 - lead to rocks or other material falling on employees
 - indicate that a wall collapse is imminent
 - lead to small material rolling into the excavation
 - tension cracks have not appeared along the top of the excavated area
 - walls are not sagging under increased pressure of an excavator, other machinery or plant
 - the surface near the excavation is not slumping which indicates that the wall is subsiding behind the support system or water is running into an excavated area from the bottom of the ground support or from between sheet piling
 - intersected joints in the walls of an excavated area, which create local unsupported wedges, are sound.
268. Any subsidence behind ground supports needs to be investigated to determine whether the ground support system is being compromised. If material is being washed away from behind, the supports will become loose, resulting in an unsupported excavation wall which could lead to ground collapse.

Appendix A – The compliance framework

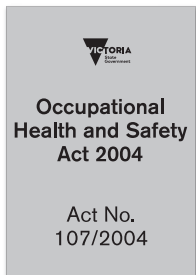

The Occupational Health and Safety Act 2004 (OHS Act) sets out the key principles, duties and rights in relation to occupational health and safety.



The Occupational Health and Safety Regulations 2017 (OHS Regulations) specify the way in which a duty imposed by the OHS Act must be performed, or prescribe procedural or administrative matters to support the OHS Act (eg requiring licences for specific activities, the keeping of records or giving notice).



Compliance codes provide practical guidance to duty holders. If a person complies with a provision of a compliance code, they are deemed to comply with the OHS legislative duty covered by the code provision. However, compliance codes are not mandatory, and a duty holder may choose to use some other way to achieve compliance.

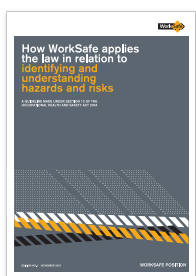

WorkSafe positions are guidelines made under section 12 of the OHS Act that state how WorkSafe will apply the OHS Act or OHS Regulations or exercise discretion under a provision of the OHS Act or OHS Regulations. WorkSafe positions are intended to provide certainty to duty holders and other affected parties.

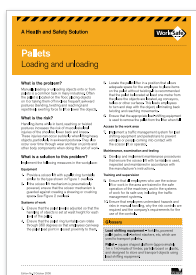

Non-statutory guidance includes information published by WorkSafe aimed at building people's knowledge and awareness of OHS issues, risks to health and safety, and the disciplines and techniques that can be applied to manage and control risks. Non-statutory guidance is not mandatory, nor does it provide any *deemed to comply* outcomes for duty holders. This guidance does, however, form part of the *state of knowledge* about OHS.

Appendix B – Sample health and safety coordination plan

Health and safety coordination plan

Project:		Location:	
Prepared by:		Date:	
Name of principal contractor:		Phone number:	

Note: A co-ordination plan must be reviewed if there are any significant changes to the work. It must be available for inspection by anyone doing construction work on the project, new employees, health and safety representatives, and members of the health and safety committee.

People with specific health and safety responsibilities

Name	Position	Phone number	Brief description of OHS responsibilities

Arrangements for co-ordinating the health and safety of the project

Describe the responsibilities for the arrangements. Include the arrangements for communicating with contractors and others who may be off-site from time to time.

Item	Responsible person

Health and safety coordination plan (continued)

Arrangements for managing health and safety incidents

Include responsibilities for notifying emergency services and WorkSafe.

Item	Responsible person

Site safety rules

Each rule should be simple and clear, covering only one issue. Set out who is covered by each rule and who is responsible for communicating it.

Item	Responsible person



Appendix C – Safe work method statement template

Sample SWMS Template for High Risk Construction Work (HRCW)

This template should be used in conjunction with WorkSafe's publication Information about Safe Work Method Statements

DUTIES:

- 1) A SWMS **must** be prepared if proposed works involve any of the HRCW activities listed below and that work poses a risk to the health and safety of any person.
- 2) Affected employees and their HSRs **must** be consulted in the preparation of the SWMS.
- 3) Once a SWMS has been developed and implemented, the HRCW to which it relates **must** be performed in accordance with the SWMS.
- 4) Duty holders (builder and sub-contractor) **must** stop the HRCW immediately or as soon as it is safe to do so if the SWMS is not being complied with; the HRCW must not resume until the SWMS is complied with or reviewed and revised as necessary.
- 5) The SWMS **must** be reviewed and if necessary, revised whenever the HRCW changes, or after any incident that occurs during HRCW, or if there is any indication that risk control measures are not adequately controlling the risks.
- 6) An employer **must** retain a copy of the SWMS for the duration of the HRCW.

Direct employer:		Principal contractor (PC): (Name and contact details)	
Work supervisor: (Name and contact details)		Date SWMS provided to PC:	
Work activity: (Job description)		Workplace and works location:	

High risk construction work:

<input type="checkbox"/> Where there is a risk of a person falling more than two metres.	<input type="checkbox"/> On or adjacent to roadways or railways used by road or rail traffic.	<input type="checkbox"/> In, over or adjacent to water or other liquids where there is a risk of drowning.
<input type="checkbox"/> At workplaces where there is any movement of powered mobile plant.	<input type="checkbox"/> Involving structural alterations that require temporary support to prevent collapse.	<input type="checkbox"/> In an area where there are artificial extremes of temperature.
<input type="checkbox"/> On or near energised electrical installations or services.	<input type="checkbox"/> Involving a trench or shaft if the excavated depth is more than 1.5 metres.	<input type="checkbox"/> On or near pressurised gas distribution mains or piping.
<input type="checkbox"/> Involving demolition.	<input type="checkbox"/> Involving a confined space.	<input type="checkbox"/> On or near chemical, fuel or refrigerant lines.
<input type="checkbox"/> Involving tilt-up or precast concrete.	<input type="checkbox"/> On telecommunications towers.	<input type="checkbox"/> Involving diving.
<input type="checkbox"/> Involving removal or likely disturbance of asbestos (note: preparation of an asbestos control plan is taken to be preparation of a SWMS).	<input type="checkbox"/> In an area that may have a contaminated or flammable atmosphere.	<input type="checkbox"/> Involving the use of explosives.
		<input type="checkbox"/> Involving a tunnel.

Person responsible for ensuring compliance with SWMS:		Date SWMS received:	
What measures are in place to ensure compliance with the SWMS? (eg direct supervision, regular spot checks)			
Person responsible for reviewing SWMS control measures (eg PC's representative):		Date SWMS received by reviewer:	
How will the SWMS control measures be reviewed?			
Review date:		Reviewer's signature:	

Selecting risk controls:
Any risk to health or safety must be **eliminated**, or if that is not reasonably practicable, **reduced** so far as is reasonably practicable by:

- implementing any mandated controls specified by law (eg the OHS Regulations 2017)
- substituting a new activity, procedure, plant, process or substance (eg scaffold in preference to ladders)
- isolating persons from the hazard (eg fence off areas for mobile plant operation)
- using engineering controls (eg guard rails, trench shields) – or a combination of the above.

If any risk to health or safety remains, it must be reduced by using:

- administration controls (eg activity specific safety training, work instructions, warning signs)
- PPE such as respiratory protection, hardhats, high visibility clothing – or a combination of the above.

↓

What are the tasks involved?	What are the hazards and risks?	What are the risk control measures?
<i>List the work tasks in a logical order.</i>	<i>What aspects of the work could harm workers or the public?</i>	<i>Describe what will be done to make the activity as safe as possible?</i>

Name of Worker	Signature	Date	Name of Worker	Signature	Date	Name of Worker	Signature	Date

Appendix D – Documents associated with this compliance code

The references listed below are not incorporated into this Code. This means that they do not form part of this Code, although they may have regulatory status in their own right. They are included only to provide an indication of sources of further information.

AS 2397: Safe use of lasers in the building and construction industry

AS 2187.2: Explosives – storage and use – use of explosives.

AS 5047: Hydraulic shoring and trench lining equipment.

AS 4744.1: Steel shoring and trench lining equipment – part 1: design.

Victorian industry standard for civil construction.



WorkSafe Agents

Agent contact details are all available at
worksafe.vic.gov.au/agents

Advisory Service

Toll-free 1800 136 089

Email info@worksafe.vic.gov.au

Head Office

1 Malop Street, Geelong 3220

Phone (03) 4243 7000

Toll-free 1800 136 089

Website worksafe.vic.gov.au

Information in your language

For information about WorkSafe in your own language, call our Translating and Interpreting Service (TIS National) on **131 450**.